



# Product Catalogue Global

January 2018

Intelligent solutions  
with lasting effect

Visit [devi.com](http://devi.com)

## Experience the luxury of electrical heating designed by DEVI

### **DEVI - Intelligent solutions with lasting effect**

DEVI provides solutions for electrical heating with a dedicated focus on advanced and user friendly systems, delivering all products dedicated to this for both indoor and outdoor.

These solutions are covered by a wide range of products e.g. heating cables, heating mats, self-limiting cables, contemporary thermostats and accessories.

DEVI's heating solutions come from a long history covering 75 years of experience resulting in powerful Danish design products build with the highest standards of quality control.

DEVI products and solutions are applied almost every- an anywhere you can imagine. We deliver these solutions literally all over the world into a wide range of purposes e.g. in- and outside residential houses and apartments, public buildings, infrastructure, sports fields and specific areas ranging from elevators, trains to airports and complete highways.

### **DEVIwarranty™ up to 20-year guarantee**

DEVI delivers high quality products with lasting effect and offers the best warranties in the market.

DEVIwarranty™ is a series of 4 individual best in the market warranties: 20-year, 10-year, 5-year and standard 2-year, to give you full peace of mind while using DEVI products in electric heating systems.

For example our 20 years DEVIwarranty™ on cables and mats not only covers the products but all costs related resulting in a Full Floor Warranty.

This product catalogue that lies in front of you covers a wide range of our products and accessories and explains what to use for what purpose.

If you still have any specific requests of questions related to these or to any specific solution that you need, please don't hesitate to contact us as we will more than likely be able to help you.

**In order to qualify for the DEVIwarranty™ please fill in the [DEVI warranty registration form](#).**

Our quality management system **certifications and compliances**



Along with full compliance with EU directives and product approvals

## Overview

### **“Floor Heating”**

*Total heating & supplementary..... 4*

### **“Ice & snow melting”**

*Ground, roof and gutters & antennas and wires.....6*

### **“Pipe tracing”**

*Frost protection & temp. maintenance..... 8*

### **“Fields”**

*Football fields & seed beds.....10*

### **“Cold stores” and “Concrete hardening”**

*Preventing frost damage to foundations and floors ..... 12*

**“Other heating elements” ..... 14**

## Floor Heating

Underfloor heating provides the most comfortable indoor climate in all rooms. The heat distributed by underfloor cables or mats is more evenly than with heating methods relying on radiators or airborne systems.

DEVI intelligent solutions are invisible and saves space by eliminating the need for radiators, pipes and other installations.

Nowadays electrical floor heating solutions with intelligent thermostats provided by DEVI are not only comfortable but also energy efficient and environmentally friendly. You have to consider what kind of heating method is suitable for your needs before installing floor heating.

### Examples of floor heating by DEVI



#### Conrad Hotel, Beijing, China

Total area extends to around 3,000 m<sup>2</sup>.  
298 bathrooms areas

##### Products

DEVIflex™ 18T (replaces DTIP)  
DEVIreg™ 330 (-10°C to 10°C)  
DEVICell™



#### Taş Evler, Antalya

Total heating installed in 16 villas  
4 000 m<sup>2</sup> - total power consumption  
is 230 kW.

##### Products

DEVIflex™ 18T – 13.750 m  
DEVIreg™ Touch – 200 pcs  
DEVIfast™ – 210 pcs



#### The Wedding Palace , Warsaw (Old Town), Poland

Project size 600 m<sup>2</sup>

##### Products

DEVImat™ 50 on 600 m<sup>2</sup>  
DEVIreg™ 550  
(replaced by DEVIreg™ Touch)



### Floor heating, total heating & supplementary heating

Total heating meaning the only source of heating and comfort heating meaning additional comfort heating. Electrical floor heating is very well suited for advanced timer-controls, so that you only heat up the room when you are actually at home, this is sound economy and good for environment.

Cables and Mats	Standard	Mechanical class	Applications			
			Concrete more than 3 cm	Thin concrete less than 3 cm	Dry solutions	Joist floors
			Page no.			
DEVIflex™ 6T (DTIP-6)	IEC60800:2009	M2		16		16
DEVIflex™ 10T (DTIP-10)	IEC60800:2009	M2	17	17		17
DEVIflex™ 18T (DTIP-18)	IEC60800:2009	M2	18			
DTCE 100T	IEC60800:2009	M2	34			
DTCE 150T	IEC60800:2009	M2	35			
DTCE 175T	IEC60800:2009	M2	36			
DTCE 200T	IEC60800:2009	M2	37			
DEVlbasic™ 10S (DSIG-10)	IEC60800:1992	C	21	21		21
DEVlbasic™ 20S - 230 V (DSIG-20)	IEC60800:1992	C	22			
DEVlbasic™ 20S - 400 V (DSIG-20)	IEC60800:1992	C	23			
DEVlbasic™ Drum Goods (DSIG)	IEC60800:1992	C	24			
DEVlheat™ 150S (DSVF-150)	IEC60335-1 + IEC60335-2-96			33		
DEVlcomfort™ 10T (DTIR-10)	IEC60335-1 + IEC60335-2-96			25	25	25
DEVlcomfort™ 100T (DTIR-100)	IEC60335-1 + IEC60335-2-96			30		
DEVlcomfort™ 150T (DTIR-150)	IEC60335-1 + IEC60335-2-96			31		
DEVlmat™ 100T (DTIF-100)	IEC60335-1 + IEC60335-2-96			27		
DEVlmat™ 150T (DTIF-150)	IEC60335-1 + IEC60335-2-96			28		
DEVlmat™ 175T (DTIF-175)	IEC60335-1 + IEC60335-2-96			36		
DEVlmat™ 200T (DTIF-200)	IEC60335-1 + IEC60335-2-96			29		
DEVldry™ Heating element 55 W	IEC60335-1 + IEC60335-2-96 + EN62233:2008				38	
DEVldry™ Heating element 100 W	IEC60335-1 + IEC60335-2-96 + EN62233:2008				39	
DEVlcell™					43	
<b>Thermostats</b>						
DEVlreg™ Smart	EN 60730-1 + EN 60730-2-9		91	91	91	91
DEVlreg™ Touch	EN 60730-1 + EN 60730-2-9		90	90	90	90
DEVlreg™ 130	EN 60730-1 + EN 60730-2-9		86	86		
DEVlreg™ 132	EN 60730-1 + EN 60730-2-9		86	86	86	86
DEVlreg™ 233	EN 60730-1 + EN 60730-2-9		96	96		
DEVlreg™ 330 (5°C to 45°C)	EN 60730-1 + EN 60730-2-9		98	98		
DEVlreg™ 527	EN 60730-1 + EN 60730-2-9		85	85		
DEVlreg™ 530	EN 60730-1 + EN 60730-2-9		88	88		
DEVlreg™ 531	EN 60730-1 + EN 60730-2-9		88	88		
DEVlreg™ 532	EN 60730-1 + EN 60730-2-9		88	88	88	88
DEVllink™ CC	EN 60730 + EN 300 220-2		92	92	92	92
DEVldry™ Plug Kit 55 W	IEC60335-2-106				40	
DEVldry™ Plug Kit 100 W	IEC60335-2-106				41	
DEVldry™ Pro Kit 100 W	IEC60730 + IEC60335-2-96				42	
DEVllink™ FT	EN 60730 + EN 300 220-2		93			
DEVllink™ RS	EN 60730 + EN 300 220-2		94			
DEVllink™ RU			95			

## Ice & snow melting

Many homeowners experience the challenges of ice and snow on the roof, in gutters, downpipes and on the driveway. Electric heating cables can minimize these problems. DEVI's ice and snow melting system is designed to provide comfort and safety for people, vehicles, and buildings.

## Ground applications

DEVI outdoor heating solutions clean snow and ice from your driveway and provide safe walking and driving.

The most common DEVI ice and snow melting applications on ground are car parks, driveways, pavements, outdoor steps, loading platforms, and bridges. DEVI's ice and snow melting system works well with most common surface covering materials such as asphalt, concrete, and tiles.

## Roof applications

Ice and snow melting systems offered by DEVI for roofs and gutters protect them from damages caused by icicles. The solution can be installed in any type of roof construction where there is a need to prevent melt water deposits in roof gutters and reduce damages to constructions like frozen facades and roofs.

In roof gutters and downpipes damage is prevented by an efficient and free draining of melt water, which naturally ensures that the system functions satisfactorily.

### Examples of ice&snow melting by DEVI



#### Örebro Castle, Sweden

Ice&snow melting system installed during complete roof renovation of the national monument

##### Products

nearly 1000 m of DEVIceguard™  
DEVI Easy Connect  
DEVireg™ 850



#### Metro, Sofia

780 square meters of stairway against ice and snow.

##### Products

Metro station 9-II "NDK":  
DEVIsnow™ 20T – 2,800 m  
DEVireg™ 850 – 3 and 8 digital ground sensors.  
Metro station 10-II "Sv. Naum":  
DEVIsnow™ 20T – 6,700 m  
DEVireg™ 850 – 3 and 12 digital round sensors.  
Metro station 11-II "James Baucher":  
DEVIsnow™ 20T – 2,050 m  
DEVireg™ 850 – 2 and 8 digital ground sensors.



#### Protokol Road, Ankara

Ice and snow melting installed on 3,5 km – total area is 17.000 m<sup>2</sup>

##### Products

DEVlasphalt 30T – < 245,000 m  
DEVireg™ 850 – 18 pcs.  
Ground Sensor – 56 pcs.  
DEVIfast™ – 4050 pcs.

### Ice & snow melting, grounds, roofs & gutters and antennas & wires

When heating cables are installed to melt snow or slippery ice from ground areas, safety and cost savings go hand in hand. These systems can be used at home in pavements, driveways and walkways or in commercial car parks, ramps, steps and areas of drainage. It can even be used to melt snow and ice from mastic asphalt surfaces.

Cables and Mats	Standard	Mechanical class	Applications				
			Frost protection - antennas / wires	Roofs and gutters	Asphalt (mastic) - high temperature	Asphalt - low temperature	Pavements, roads and ramps
			Page no.				
DEVIsnow™ 20T - 230 V (DTCE-20)	IEC60800:2009	M2	48	48		48	48
DEVIsnow™ 20T - 400 V (DTCE-20)	IEC60800:2009	M2	49	49		49	49
DEVIsnow™ 30T - 230 V (DTCE-30)	IEC60800:2009	M2	50	50		50	50
DEVIsnow™ 30T - 400 V (DTCE-30)	IEC60800:2009	M2	52	52		52	52
DEVIsnow™ Drum Goods (DTCE)	IEC60800:2009	M2	55	55		55	55
DEVIsnow™ 300T - 230 V (DTCE-300)	IEC60800:2009	M2				53	53
DEVIsnow™ 300T - 400 V (DTCE-300)	IEC60800:2009	M2				54	54
DTCE 200T	IEC60800:2009					37	37
DEVIbasic™ 20S - 230 V (DSIG-20)	IEC60800:1992	C					22
DEVIbasic™ 20S - 400 V (DSIG-20)	IEC60800:1992	C					23
DEVIbasic™ Drum Goods (DSIG)	IEC60800:1992	C					24
DEVIasphalt™ 30T (DTIK-30)	IEC60800:2009	M2			56	56	
DEVIasphalt™ 300T - 230 V (DTIK-300)	IEC60800:2009	M2			57	57	
DEVIasphalt™ 300T - 400 V (DTIK-300)	IEC60800:2009	M2			58	58	
DEVIsafe™ 20T	IEC60800:2009	M2	47	47		47	47
DEVliceeguard™ 18 Drum (B)			70	70			
DEVliceeguard™ 18 Drum / Readymade (T)			72	72			
<b>Thermostats</b>							
DEVIreg™ Touch	EN 60730-1 + EN 60730-2-9		90				
DEVIreg™ 130	EN 60730-1 + EN 60730-2-9		86				
DEVIreg™ 132	EN 60730-1 + EN 60730-2-9		86				
DEVIreg™ 233	EN 60730-1 + EN 60730-2-9		96				
DEVIreg™ 316	EN 60730-1 + EN 60730-2-9		100			100	100
DEVIreg™ 330 (-10°C to 10°C)	EN 60730-1 + EN 60730-2-9		98		98	98	98
DEVIreg™ 330 (5°C to 45°C)	EN 60730-1 + EN 60730-2-9		98				
DEVIreg™ 330 (60°C to 160°C)	EN 60730-1 + EN 60730-2-9		98				
DEVIreg™ 527	EN 60730-1 + EN 60730-2-9		88				
DEVIreg™ 530	EN 60730-1 + EN 60730-2-9		88				
DEVIreg™ 531	EN 60730-1 + EN 60730-2-9		88				
DEVIreg™ 532	EN 60730-1 + EN 60730-2-9		88				
DEVIreg™ 610	EN 60730-1 + EN 60730-2-9		101		101	101	101
DEVIreg™ 850	EN 60730-1 + EN 60730-2-9			102	102		102

## Pipe tracing

DEVI's pipe tracing systems may be used for two main purposes:

1. Frost protection systems are installed where there is a need to prevent water and sanitary pipes from freezing and becoming ice-damaged.
2. Temperature maintenance systems ensure that hot water or fluid pipes maintain the required temperature.

DEVI's pipe tracing systems may be used on the inside and outside of pipes, for indoor and outdoor pipe networks as well as for pipes above and below the ground.

The advantages of the pipe tracing systems are:

- Ice-free pipes
- Constant flow in pipes
- Depth reduction for underground pipes
- No repair costs after a hard winter
- No hardening of fatty products in pipe systems
- Efficient hot water supply

### Examples of pipe tracing by DEVI



#### Situla Building, Ljubljana, Slovenia

DEVI was chosen for the pipe tracing solutions and heating roof, gutters & down pipes, as well as parking entrance.

##### Products

DEVIpipeguard™ 10 self-limiting cable  
 DEVIpipeguard™ 25 self-limiting cable  
 DEVIreg™ 330 thermostats  
 DEVIsnow™ 30T  
 DEVIreg™ 850 – 10 pcs.  
 Roof Sensors – 5 pcs  
 Ground Sensors – 13 pcs



#### Gas accounting knot, Odessa, Ukraine

All new knots were insulated and DEVI system was installed. Construction was slightly changed – cable is fixed with a glue stripe to the foliage of galvanized iron and it is placed in the knot bottom cable side down.

##### Products

DEVIflex™ 14 m  
 DEVIreg™ 131



#### Pipeline in Strzelce Opolskie, Poland

Electric heating of pipes to protect them against frost damage.

##### Products

DEVIflex™ 18  
 DEVIreg™ 330

### Pipe tracing, frost protection and temperature maintenance

During the winter, problems with frost in fresh water pipes, waste water pipes, cooling water pipes, supply water pipes and sprinkler systems can be avoided by heating the pipes internally or externally. The DEVI systems provide either a constant wattage system or a self-limiting system-

			Applications		
			Pipe tracing - temp. maintenance, externally	Pipe tracing - frost protection, externally	Pipe tracing - frost protection, internally
<b>Cables and Mats</b>	<b>Standard</b>	<b>Mechanical class</b>	<b>Page no.</b>		
DEVIflex™ 6T (DTIP-6)	IEC60800:2009	M2		16	
DEVIflex™ 10T (DTIP-10)	IEC60800:2009	M2		17	
DEVlaqua™ 9T	IEC60800:2009	M1			45
DEVlbasic™ 10S (DSIG-10)	IEC60800:1992	C		21	
DEVlbasic™ 20S - 230 V (DSIG-20)	IEC60800:1992	C		22	
DEVlbasic™ 20S - 400 V (DSIG-20)	IEC60800:1992	C		23	
DEVlbasic™ Drum Goods (DSIG)	IEC60800:1992	C		24	
DEVImulti™ HDPE (DMIT)	IEC60800:1992	C		76	
DEVImulti™ PVC (DMIH)	IEC60800:1992	C		76	
DEVlhotwatt™ 45			74		
DEVlhotwatt™ 55			74		
DEVlhotwatt™ 70			74		
DEVlpipeguard™ 10 (B)				60	
DEVlpipeguard™ 25 (B)				60	
DEVlpipeguard™ 33 (B)				60	
DEVlpipeguard™ 10 (T)				64	
DEVlpipeguard™ 25 (T)				64	
DEVlpipeguard™ 33 (T)				64	
DEVlpipeheat™ 10 w/plug				44	44
DEVliceguard™ 18 Drum (B)				70	
DEVliceguard™ 18 Drum / Readymade (T)				72	
DEVlpipeguard™ 30 Industry (PT-30)				68	
DEVlpipeguard™ 60 Industry (PT-60)				68	
DEVlhightemp™ (DSIX)			78		
<b>Thermostats</b>					
DEVlreg™ 316	EN 60730-1 + EN 60730-2-9			100	100
DEVlreg™ 330 (-10°C to 10°C)	EN 60730-1 + EN 60730-2-9			98	98
DEVlreg™ 330 (5°C to 45°C)	EN 60730-1 + EN 60730-2-9			98	98
DEVlreg™ 330 (60°C to 160°C)	EN 60730-1 + EN 60730-2-9		98	98	68
DEVlreg™ 610	EN 60730-1 + EN 60730-2-9		101	101	101



## Fields

DEVI electrical heating is the best solution for sports fields such as stadiums or golf-links but also for seed beds. Heating of seed beds can be used in greenhouses, cutting beds, seed beds and reproduction boxes.

## Sport fields heating

With DEVI electric heating solutions installed in football fields or golf courses the soil can be heated and the growth of grass can start in the early spring. The area will then be ready up to two months earlier than usual. Furthermore, the season can be prolonged in autumn when the period until the grass stops growing can be extended by means of heating the roots. Not only does DEVI very efficiently and energy aware prevent the field with artificial grass from being hit with frost and or snow when this is needed, it also serves as a growth and restoration stimulator for the natural grass. All this ensures a better pitch that can be used to the max irrespective of the season or location.

Applications for natural field grass keep the ground temperature on a certain level. They help to maintain and evolve the roots grass.

Artificial grass applications keep the field free from ice and snow.

### Examples of fields heating by DEVI



#### RSCA Anderlecht Stadium, Bruxelles, Belgium

Seed beds heating – 8000 m heated with 83 W/m<sup>2</sup> divided in 4 zones

#### Products

DEVIflex™ DSM3 ready made with DSWA cold tail.



#### Reyford Golf Club – Golf Green Field Heating, Youngchun City, Kyungsangbuk-do

Golf Green Soil Heating to prevent icing and to facilitate the grass growing

#### Products

DEVIsnow™ 30 – 24 pcs (16 Rolls for 5th Green and 8 Rolls for Practice Green)



#### Fredrikstad Stadium, Norway

Electrical heating extends the seasonal use of the facilities equipped with artificial grass

#### Products

DEVIheat™ 90 – 228 pcs.

## Seed beds heating

In order to speed up vegetation and reproduction in greenhouses the soil may be heated from early spring so the vegetation starts earlier and the harvest lasts longer. Besides, it facilitates the cultivation of heat requiring plants which normally only grow in subtropical/tropical latitudes.

In order to reach the necessary temperatures DEVI heating solutions are ideal and if they are equipped with electronic DEVIreg™ thermostats and sensors, the energy consumption will be minimal.

### Examples of seed beds heating by DEVI



#### Atatürk Horticultural Central Research Institute, Yalova, Turkey

Seed beds heating on 2 tables of greenhouse sample – 15x1m<sup>2</sup> each

#### Products

DEVIflex™ 10 – 280 m

DEVIreg™ 535 – 2 pcs

DEVIfast™ – 1 pc



### Fields, football fields and seed beds

With DEVI heating cables or heating mats in the ground you can heat the field and start the growing season early in the spring. The field can be ready for use up to two months earlier than usual. In this way the season can also be prolonged well into the autumn. DEVI also has excellent solutions for fields with artificial grass.

			Applications		
			Seed beds	New fields	Existing fields
			Page no.		
<b>Cables and Mats</b>	<b>Standard</b>	<b>Mechanical class</b>			
DEVIflex™ 10T (DTIP-10)	IEC60800:2009	M2	17		
DEVIflex™ 18T (DTIP-18)	IEC60800:2009	M2	18		
DEVIsnow™ 20T - 230 V (DTCE-20)	IEC60800:2009	M2		48	
DEVIsnow™ 20T - 400 V (DTCE-20)	IEC60800:2009	M2		49	
DEVIsnow™ 30T - 230 V (DTCE-30)	IEC60800:2009	M2		50	
DEVIsnow™ 30T - 400 V (DTCE-30)	IEC60800:2009	M2		52	
DEVIsnow™ Drum Goods (DTCE)	IEC60800:2009	M2		55	
DEVIsnow™ 300T - 230 V (DTCE-300)	IEC60800:2009	M2		53	
DEVIsnow™ 300T - 400 V (DTCE-300)	IEC60800:2009	M2		54	
DEVIbasic™ 10S (DSIG-10)	IEC60800-1992	C	21		
DEVIbasic™ 20S - 230 V (DSIG-20)	IEC60800-1992	C	22		
DEVIbasic™ 20S - 400 V (DSIG-20)	IEC60800-1992	C	23		
DEVIbasic™ Drum Goods (DSIG)	IEC60800-1992	C	24		
DEVIsport™ (DSM3)	NF C 32-330:2002	MMM			82
DEVIsafe™ 20T - 230 V	IEC60800:2009	M2		46	
DEVIsafe™ 20T - 400 V	IEC60800:2009	M2		47	
DEVIimat™ DSVF-90	IEC60335-1 + IEC60335-2-96			80	
<b>Thermostats</b>					
DEVIreg™ 316	EN 60730-1 + EN 60730-2-9		100		
DEVIreg™ 330 (-10°C to 10°C)	EN 60730-1 + EN 60730-2-9		98		
DEVIreg™ 330 (5°C to 45°C)	EN 60730-1 + EN 60730-2-9		98		
DEVIreg™ 610	EN 60730-1 + EN 60730-2-9		101		

## Cold stores

Heating up the floor construction in a cold store is a necessity in order to protect the building from the floor in cold stores or ice stadiums, etc.

In cold stores where the temperature is constantly between -20 and -30°C, coldness will still be given off to the surroundings even though the floor is well insulated.

## Condensation protection of floors

In doorways between cold stores and heated rooms condensed water may form on the floor due to the constant shifts between cold and warm air caused by the opening and closing of doors. This can result in dangerous ice formations on the floor and therefore, the floor in these areas must be heated. As an extra comfort it will also limit the flow of cold air to the heated area.

## Floors

In cold stores where the temperature constantly lies between -20 and -30°C, cold will still be released to the surroundings even though the floor is well-insulated. This means that the materials which are in contact with the ground/soil, such as foundation and floor areas, will absorb the cold and leave the ground/soil to freeze. The water content in the ground/soil will expand and this can cause considerable damages due to frost erosion. The same problem also appears in ice stadiums, which are artificially frozen. This can be avoided with DEVI's frost protection system, though.

### Examples of cold stores heating by DEVI



#### Regional logistics center, Kiev, Ukraine

Cold stores: the DEVI system was installed under the floor 2 freezers, area 1720 sq. m. each, with an operating temperature of minus 22°C.

Project size: 2 x 1720 m<sup>2</sup>

#### Products

DEVIflex™ – 7560 m

DEVIREG™ 535 – 6 pcs

#### Divan Taşdelen Bakery Facilities, İstanbul, Turkey

Electrical Underfloor Heating, Frost Protection – Cold Room  
Project Size: 2000m<sup>2</sup>

#### Products

DEVIflex™ 10T – 5 660 m

DEVIREG™ 330 – 24 pcs.

DEVIfast™ – 314 pcs.

#### Panda, Jeddah, Saudi Arabia

DEVI electrical heating solutions will be used for the protection of thresholds and floor of the biggest Middle Eastern cold store. The total size of the project is 8,000 m<sup>2</sup> and total installed power is approximately 160 kW.

#### Products

DEVIflex™ 192m – 14 pcs

DEVIflex™ 229m – 73 pcs

DEVIsnow™ 63m – 13 pcs

DEVIsnow™ 140m – 18 pcs

DEVIfast™ – 982 pcs

DEVIREG™ 330 with sensor-10-+10°C,

## Heating of thermal bridges

DEVI's heating systems can be used to avoid temperature differences in floors caused by thermal bridges. DEVI's heating systems can also be used to avoid or limit draughts, e.g. at windows, doors, exterior walls, and central elements in concrete buildings.

# Concrete hardening

In connection with casting processes during winter time, it can often be difficult to ensure the correct strength of the concrete as well as to achieve a uniform result of the surface, when temperatures fall below the freezing point.

To avoid unnecessary and expensive delays of the building activities it often can be necessary to add a little extra heat, to keep up the correct temperature to sustain the hardening process.

This problem may in many cases be solved, by embedding heating cables in the concrete construction attached directly to the reinforcement mesh and raising the temperature some degrees to maintain the natural process.

If the temperature is -10°C or above it is normally not necessary to protect the concrete construction further, but if the temperature falls below -10°C it is recommended to sheet the construction over. Depending on the outdoor temperature the system can be maintained at approx. +1 to +2°C for a week. Then, it is possible to reduce the effect gradually.

## Example of concrete hardening by DEVI



### Bjørvika tunnel Oslo, Norway

Bjørvika tunnel links Festning tunnel in Oslo west with Ekeberg tunnel in Oslo east.

DEVI was chosen to harden the concrete in roof and walls in the immersed part of the tunnel

Project size: 1 100 meters of tunnels, 675 meters of which is immersed

#### Products

DEVIflex™  
DEVlreg™ 330

<b>Cold stores and concrete hardening, preventing frost damage to foundations and floors</b>					
In cold stores (and ice stadiums) where the temperature constantly is between -20°C and -30°C cold will be emitted to the surroundings in spite of good insulation. This means that the floor will freeze as well as the soil below. The water in the soil expands which can lead to frost damage to the foundation / floor. This can be prevented by using DEVI heating cables.					
			Applications		Page no.
			Cold stores	Concrete hardening	
<b>Cables and Mats</b>	<b>Standard</b>	<b>Mechanical class</b>			
DEVIflex™ 10T (DTIP-10)	IEC60800:2009	M2	17		
DEVIflex™ 18T (DTIP-18)	IEC60800:2009	M2	18		
DEVIflex™ 30T (DTIP-30)	IEC60800:2009	M2		19	
DEVIsnow™ 20T - 230 V (DTCE-20)	IEC60800:2009	M2	48		
DEVIsnow™ 20T - 240 V (DTCE-20)	IEC60800:2009	M2	49		
DEVIsnow™ Drum Goods (DTCE)	IEC60800:2009	M2	55		
DEVIbasic™ 10S (DSIG-10)	IEC60800:1992	M2	21		
DEVIbasic™ 20S - 230 V (DSIG-20)	IEC60800:1992	C	22		
DEVIbasic™ 20S - 400 V (DSIG-20)	IEC60800:1992	C	23		
DEVIbasic™ Drum Goods (DSIG)	IEC60800:1992	C	24		
<b>Thermostats</b>					
DEVlreg™ 316	EN 60730-1 + EN 60730-2-9		100		
DEVlreg™ 330 (-10°C to 10°C)	EN 60730-1 + EN 60730-2-9		98		
DEVlreg™ 610	EN 60730-1 + EN 60730-2-9		101		

## Other heating elements

Heating elements	Standard	Applications
		Heating elements
		Page no.
DEVIfoil™ Ceiling	60800:2009	84
DEVItemp™ Fan heater	60800:2009	106
DEVItronic™	60800:2009	107
DEVIlrail™	60800:2009	108
DEVIfoil™ Mirror	60800:2009	83
DEVIheat™ Mirror 150S	IEC60335-1 + IEC60335-2-96	33



# DEVI products

## Data sheets

Intelligent solutions  
with lasting effect

Visit [devi.com](http://devi.com)



## DEVIflex™ 6T (DTIP-6)



DEVIflex™ is an extremely high-quality, 360° fully screened twin conductor cable with a tough outer sheath (non UV stable). Its round profile and robust construction ensures a fast, simple and safe installation in multiple indoor floor constructions and pipe tracing applications.

The cold lead is an installation cable with solid conductors ensuring fast installation. A clearly visible connection avoids accidentally installing the heated cable in the wall.

To ensure a long life-time, all cables are minutely inspected including tests for Ohmic resistance, high voltage and material controls to ensure the quality. This means that we are proud to supply our full floor extended DEVIflex™ warranty™.

**20**  
YEAR  
WARRANTY

Product    Installation    Floor/Surface

### Benefits:

- Fast and easy to install
- Multiple application options
- Safe and robust
- Long life-time
- Maximum protection

### Standard compliance:

- IEC60800:2009

### Approvals:



Type	Value
Operation voltage	220 - 240 V~
Construction	Round, twin conductor with 360° screen, one cold lead
Output	6 W/m @ 230 V~
Max. permissible use temperature, powered	80 °C
Max. permissible use temperature, unpowered	90 °C
Cable dimensions	Ø 6,9 mm
Deformation strength	>1500 N
Pulling strength	>500 N
Conductor insulation	XLPE
Outer sheath	PVC, red
Screen	100% coverage; alu-foil; 0,5 mm <sup>2</sup> tinned copper drain wire
Cold lead	2,3 m DTCL, 3 x 1,5 mm <sup>2</sup>
Min. installation temperature	-5 °C
Bending Ø, min.	50 mm
IP Class	IPX7

### Types

Item no.	Cable length, m	Output, W @ 230 V~	Resistance, Ohm	EAN no.
140F1200	30	180	293,4	5703466223369
140F1201	40	250	211,6	5703466223376
140F1202	50	310	170,0	5703466223383
140F1203	60	345	152,4	5703466223390
140F1204	70	415	128,1	5703466223406
140F1205	80	500	105,6	5703466223413
140F1206	90	540	98,1	5703466223420
140F1207	100	635	83,6	5703466223437
140F1208	115	720	74,0	5703466223444
140F1209	129	770	68,9	5703466223451
140F1210	140	870	60,8	5703466223468
140F1211	160	915	57,9	5703466223475
140F1212	180	1095	48,2	5703466223482
140F1213	190	1160	45,6	5703466223499
140F1214	200	1260	42,0	5703466223505



## DEVIflex™ 10T (DTIP-10)



DEVIflex™ is an extremely high-quality, 360° fully screened twin conductor cable with a tough outer sheath (non UV stable). Its round profile and robust construction ensures a fast, simple and safe installation in multiple indoor floor constructions and pipe tracing applications.

The cold lead is an installation cable with solid conductors ensuring fast installation. A clearly visible connection avoids accidentally installing the heated cable in the wall.

To ensure a long life-time, all cables are minutely inspected including tests for Ohmic resistance, high voltage and material controls to ensure the quality. This means that we are proud to supply our full floor extended DEVIwarranty™.

20

YEAR  
WARRANTY



Product



Installation



Floor/Surface

### Benefits:

- Fast and easy to install
- Multiple application options
- Safe and robust
- Long life-time
- Maximum protection

### Standard compliance:

- IEC60800:2009

### Approvals:



Type	Value
Operation voltage	220 - 240 V~
Construction	Round, twin conductor with 360° screen, one cold lead
Output	10 W/m @ 230 V~
Max. permissible use temperature, powered	75 °C
Max. permissible use temperature, unpowered	90 °C
Cable dimensions	Ø 6,9 mm
Deformation strength	>1500 N
Pulling strength	>500 N
Conductor insulation	PEX
Outer sheath	PVC, red
Screen	100% coverage; alu-foil; 0,5 mm <sup>2</sup> tinned copper drain wire
Cold lead	2,3 m DTCL
Min. installation temperature	-5 °C
Bending Ø, min.	50 mm
IP Class	IPX7

### Types

Item no.	Cable length, m	Output, W @ 230 V~	Resistance, Ohm	Cold lead, mm <sup>2</sup>	EAN no.
140F1215	2	20	2646,0	3 x 1,5	5703466223512
140F1216	4	40	1324,0	3 x 1,5	5703466223529
140F1217	6	60	882,0	3 x 1,5	5703466223536
140F1218	8	80	660,8	3 x 1,5	5703466223543
140F1219	10	100	529,0	3 x 1,5	5703466223550
140F1407	15	135	403,5	3 x 1,5	5703466227794
140F1220	20	205	260,0	3 x 1,5	5703466223567
140F1408	25	241	219,5	3 x 1,5	5703466227800
140F1221	30	290	183,0	3 x 1,5	5703466223574
140F1409	35	365	145,0	3 x 1,5	5703466227817
140F1222	40	390	136,0	3 x 1,5	5703466223581
140F1223	50	505	105,0	3 x 1,5	5703466223598
140F1224	60	600	88,2	3 x 1,5	5703466223604
140F1225	70	695	76,3	3 x 1,5	5703466223611
140F1226	80	790	66,9	3 x 1,5	5703466223628
140F1227	90	920	57,4	3 x 1,5	5703466223635
140F1228	100	990	53,4	3 x 1,5	5703466223642
140F1229	120	1220	43,4	3 x 1,5	5703466223659
140F1230	140	1410	37,5	3 x 1,5	5703466223666
140F1231	160	1575	33,6	3 x 1,5	5703466223673
140F1232	180	1760	30,1	3 x 2,5	5703466223680
140F1233	200	1990	26,6	3 x 2,5	5703466223697
140F1234	210	2050	25,8	3 x 2,5	5703466223703

## DEVIflex™ 18T (DTIP-18)



DEVIflex™ is an extremely high-quality, 360° fully screened twin conductor cable with a tough outer sheath (non UV stable). Its round profile and robust construction ensures a fast, simple and safe installation in multiple indoor floor constructions and pipe tracing applications.

The cold lead is an installation cable with solid conductors ensuring fast installation. A clearly visible connection avoids accidentally installing the heated cable in the wall.

To ensure a long life-time, all cables are minutely inspected including tests for Ohmic resistance, high voltage and material controls to ensure the quality. This means that we are proud to supply our full floor extended DEVIwarranty™.

**20 YEAR WARRANTY**

Product Installation Floor/Surface

### Benefits:

- Fast and easy to install
- Multiple application options
- Safe and robust
- Long life-time
- Maximum protection

### Standard compliance:

- IEC60800:2009

### Approvals:



Type	Value
Operation voltage	220 - 240 V~
Construction	Round, twin conductor with 360° screen, one cold lead
Output	18 W/m @ 230 V~
Max. permissible use temperature, powered	60 °C
Max. permissible use temperature, unpowered	90 °C
Cable dimensions	Ø 6,9 mm
Deformation strength	>1500 N
Pulling strength	>500 N
Conductor insulation	XLPE
Outer sheath	PVC, red
Screen	100% coverage; alu-foil; 0,5 mm <sup>2</sup> tinned copper drain wire
Cold lead	2,3 m DTCL
Min. installation temperature	-5 °C
Bending Ø, min.	50 mm
IP Class	IPX7

### Types

Item no.	Cable length, m	Output, W @ 230 V~	Resistance, Ohm	Cold lead, mm <sup>2</sup>	EAN no.
140F1235	7,3	130	410,3	3 x 1,5	5703466223710
140F1236	10	180	294,0	3 x 1,5	5703466223727
140F1400	12,8	230	230,4	3 x 1,5	5703466226278
140F1237	15	270	195,0	3 x 1,5	5703466223734
140F1401	17,5	310	171,2	3 x 1,5	5703466226285
140F1238	22	395	134,2	3 x 1,5	5703466223741
140F1239	29	535	98,6	3 x 1,5	5703466223758
140F1240	34	615	86,4	3 x 1,5	5703466223765
140F1241	37	680	77,7	3 x 1,5	5703466223772
140F1242	44	820	64,7	3 x 1,5	5703466223789
140F1243	52	935	56,7	3 x 1,5	5703466223796
140F1410	54	1005	52,7	3 x 1,5	5703466227992
140F1244	59	1075	49,3	3 x 1,5	5703466223802
140F1245	68	1220	43,4	3 x 1,5	5703466223819
140F1246	74	1340	39,5	3 x 1,5	5703466223826
140F1247	82	1485	35,6	3 x 1,5	5703466223833
140F1248	90	1625	32,6	3 x 1,5	5703466223840
140F1249	105	1880	28,1	3 x 2,5	5703466223857
140F1250	118	2135	24,8	3 x 2,5	5703466223864
140F1251	131	2420	21,9	3 x 2,5	5703466223871
140F1252	155	2775	19,1	3 x 2,5	5703466223888
140F1402	170	3050	17,3	3 x 2,5	5703466226292

## DEVIflex™ 30T (DTIP-30)



DEVIflex™ 30T is an extremely high-quality, 360° fully screened twin conductor cable with a tough outer sheath (non UV stable). It has a round profile and robust construction which ensures a fast, simple and safe installation. It is designed for concrete hardening only.

The cold lead is an installation cable with solid conductors ensuring fast installation. A clearly visible connection avoids accidentally installing the heated cable in the wall.

To ensure a long life-time, all cables are minutely inspected including tests for Ohmic resistance, high voltage and material controls to ensure the quality. This means that we are proud to supply our full floor extended DEVIwarranty™.

20

YEAR  
WARRANTY



Product



Installation



Floor/Surface

### Benefits:

- Fast and easy to install
- Safe and robust
- Long life-time
- Maximum protection

### Standard compliance:

- IEC60800:2009

### Approvals:



Type	Value
Operation voltage	220 - 240 V~
Construction	Round, twin conductor with 360° screen, one cold lead
Output	30 W/m @ 230 V~
Max. permissible use temperature, powered	45 °C
Max. permissible use temperature, unpowered	90 °C
Cable dimensions	Ø 6,9 mm
Deformation strength	1500 N
Pulling strength	500 N
Conductor insulation	XLPE
Outer sheath	PVC, red
Screen	100% coverage; alu-foil; 0,5 mm <sup>2</sup> tinned copper drain wire
Cold lead	2,3 m DTWC, 3 x 1,5mm <sup>2</sup>
Min. installation temperature	-5 °C
Bending Ø, min.	50 mm
IP Class	IPX7

### Types

Item no.	Cable length, m	Output, W @ 230 V~	Resistance, Ohm	EAN no.
140F1271	45	1405	37,6	5703466224076
140F1272	90	2800	18,9	5703466224083





**20**  
YEAR  
WARRANTY

Product Installation Floor/Surface

## DEVIbasic™ 10S (DSIG-10)

DEVIbasic™ is a high-quality, braided screen, single conductor cable with a non UV stable outer sheath. Its round profile and robust construction ensures a fast, simple and safe installation in multiple indoor, outdoor and pipe tracing applications.

The two cold leads have clearly visible connections to avoid accidentally installing the heated cable in the wall.

To ensure a long life-time, all cables are minutely inspected including tests for Ohmic resistance, high voltage and material controls to ensure the quality. This means that we are proud to supply our full floor extended DEVIwarranty™.

### Benefits:

- Easy to install
- Multiple application options
- Safe and robust
- Long life-time

### Standard compliance:

- IEC60800:1992

### Approvals:



Type	Value
Operation voltage	220 - 240V
Construction	Round, single conductor with screen, 2 x cold lead
Output	10 W/m @ 230V~
Max. permissible use temperature, powered	75 °C
Max. permissible use temperature, unpowered	90 °C
Cable dimensions	Ø 5,5 mm
Deformation strength	600 N
Pulling strength	120 N
Conductor insulation	XLPE
Outer sheath	PVC
Screen	16 x 0,3 mm Cu (1 mm <sup>2</sup> )
Cold lead	2 x 3 m DSWA, single conductor with screen
Min. installation temperature	-5 °C
Bending Ø, min.	50 mm
IP Class	IPX7

### Types

Item no.	Cable length	Output @ 230V~	Resistance	Cold lead	EAN no.
84001500	21 m	202 W	261,9 Ω	1 x 1,5 mm <sup>2</sup>	5703466118931
84001505	26 m	268 W	197,4 Ω	1 x 1,5 mm <sup>2</sup>	5703466118948
84001510	30 m	299 W	176,9 Ω	1 x 1,5 mm <sup>2</sup>	5703466118955
84001515	37 m	376 W	140,7 Ω	1 x 1,5 mm <sup>2</sup>	5703466118962
84001520	46 m	446 W	118,6 Ω	1 x 1,5 mm <sup>2</sup>	5703466118979
84001525	50 m	501 W	105,6 Ω	1 x 1,5 mm <sup>2</sup>	5703466118986
84001530	58 m	570 W	92,8 Ω	1 x 1,5 mm <sup>2</sup>	5703466118993
84001535	66 m	668 W	79,2 Ω	1 x 1,5 mm <sup>2</sup>	5703466119006
84001540	77 m	763 W	69,3 Ω	1 x 1,5 mm <sup>2</sup>	5703466119013
84001545	90 m	904 W	58,5 Ω	1 x 1,5 mm <sup>2</sup>	5703466119020
84001550	103 m	1027 W	51,5 Ω	1 x 1,5 mm <sup>2</sup>	5703466119037
84001555	114 m	1133 W	46,7 Ω	1 x 1,5 mm <sup>2</sup>	5703466119044
84001560	125 m	1245 W	42,5 Ω	1 x 1,5 mm <sup>2</sup>	5703466119051
84001565	140 m	1400 W	37,8 Ω	1 x 1,5 mm <sup>2</sup>	5703466119068
84001570	159 m	1584 W	33,4 Ω	1 x 1,5 mm <sup>2</sup>	5703466119075
84001575	170 m	1707 W	31,0 Ω	1 x 1,5 mm <sup>2</sup>	5703466119082
84001580	188 m	1876 W	28,2 Ω	1 x 1,5 mm <sup>2</sup>	5703466119099
84001585	230 m	2300 W	23,0 Ω	1 x 2,5 mm <sup>2</sup>	5703466119105
84001590	275 m	2741 W	19,3 Ω	1 x 2,5 mm <sup>2</sup>	5703466119112
84001595	325 m	3245 W	16,3 Ω	1 x 4,0 mm <sup>2</sup>	5703466119129
84001600	407 m	4069 W	13,0 Ω	1 x 4,0 mm <sup>2</sup>	5703466119136



**20**  
YEAR  
WARRANTY

Product Installation Floor/Surface

## DEVIbasic™ 20S - 230V (DSIG-20)

DEVIbasic™ is a high-quality, braided screen, single conductor cable with a non UV stable outer sheath. Its round profile and robust construction ensures a fast, simple and safe installation in multiple indoor, outdoor and pipe tracing applications.

The two cold leads have clearly visible connections to avoid accidentally installing the heated cable in the wall.

To ensure a long life-time, all cables are minutely inspected including tests for Ohmic resistance, high voltage and material controls to ensure the quality. This means that we are proud to supply our full floor extended DEVIwarranty™.

### Benefits:

- Easy to install
- Multiple application options
- Safe and robust
- Long life-time

### Standard compliance:

- IEC60800:1992

### Approvals:



Type	Value
Operation voltage	220 - 240 V
Construction	Round, single conductor with screen, 2 x cold lead
Output	20 W/m @ 230 V~
Max. permissible use temperature, powered	60 °C
Max. permissible use temperature, unpowered	90 °C
Cable dimensions	Ø 5,5 mm
Deformation strength	600 N
Pulling strength	120 N
Conductor insulation	XLPE
Outer sheath	PVC
Screen	16 x 0,3 mm Cu (1 mm <sup>2</sup> )
Cold lead	2 x 3 m DSWA, single conductor with screen
Min. installation temperature	-5 °C
Bending Ø, min.	50 mm
IP Class	IPX7

### Types

Item no.	Cable length	Output @ 230V~	Resistance	Cold lead	EAN no.
140F0260	9 m	155 W	347,3 Ω	1 x 1,5 mm <sup>2</sup>	5703466208939
140F0215	14 m	260 W	203,5 Ω	1 x 1,5 mm <sup>2</sup>	5703466202289
140F0216	18 m	375 W	141,1 Ω	1 x 1,5 mm <sup>2</sup>	5703466202296
140F0217	26 m	520 W	101,7 Ω	1 x 1,5 mm <sup>2</sup>	5703466202302
140F0218	32 m	640 W	82,7 Ω	1 x 1,5 mm <sup>2</sup>	5703466202319
140F0219	39 m	800 W	66,1 Ω	1 x 1,5 mm <sup>2</sup>	5703466202326
140F0220	53 m	1070 W	49,4 Ω	1 x 1,5 mm <sup>2</sup>	5703466202333
140F0221	63 m	1260 W	42,0 Ω	1 x 1,5 mm <sup>2</sup>	5703466202340
140F0222	74 m	1465 W	36,1 Ω	1 x 1,5 mm <sup>2</sup>	5703466202357
140F0223	91 m	1820 W	29,1 Ω	1 x 1,5 mm <sup>2</sup>	5703466202364
140F0224	110 m	2215 W	23,9 Ω	1 x 1,5 mm <sup>2</sup>	5703466202371
140F0225	131 m	2640 W	20,0 Ω	1 x 2,5 mm <sup>2</sup>	5703466202388
140F0226	159 m	3170 W	16,7 Ω	1 x 2,5 mm <sup>2</sup>	5703466202395
140F0227	192 m	3855 W	13,7 Ω	1 x 2,5 mm <sup>2</sup>	5703466202401
140F0228	228 m	4565 W	11,6 Ω	1 x 4,0 mm <sup>2</sup>	5703466202418





**20**  
YEAR  
WARRANTY

Product Installation Floor/Surface

## DEVIbasic™ 20S - 400V (DSIG-20)

DEVIbasic™ is a high-quality, braided screen, twin conductor cable with a tough outer sheath (non UV stable). Its round profile and robust construction ensures a fast, simple and safe installation in multiple indoor, outdoor and pipe tracing applications.

The two cold leads have clearly visible connections to avoid accidentally installing the heated cable in the wall.

To ensure a long life-time, all cables are minutely inspected including tests for Ohmic resistance, high voltage and material controls to ensure the quality. This means that we are proud to supply our full floor extended DEVIwarranty™.

### Benefits:

- Easy to install
- Multiple application options
- Safe and robust
- Long life-time

### Standard compliance:

- IEC60800:1992

### Approvals:



Type	Value
Operation voltage	400 V~
Construction	Round, single conductor with screen, 2 x cold lead
Output	20 W/m @ 400 V~
Max. permissible use temperature, powered	60 °C
Max. permissible use temperature, unpowered	90 °C
Cable dimensions	Ø 5,5 mm
Deformation strength	600 N
Pulling strength	120 N
Conductor insulation	XLPE
Outer sheath	PVC
Screen	16 x 0,3 mm Cu (1 mm <sup>2</sup> )
Cold lead	2 x 3 m DSWA, 1 x 1,5 mm <sup>2</sup> , single conductor with screen
Min. installation temperature	-5 °C
Bending Ø, min.	50 mm
IP Class	IPX7

### Types

Item no.	Cable length	Output @ 400V~	Resistance	EAN no.
140F0229	56 m	1100 W	145,5 Ω	5703466202425
140F0230	69 m	1375 W	116,4 Ω	5703466202432
140F0231	93 m	1850 W	86,5 Ω	5703466202449
140F0232	126 m	2250 W	71,1 Ω	5703466202456
140F0233	158 m	3175 W	50,4 Ω	5703466202463
140F0234	192 m	3850 W	41,6 Ω	5703466202470
140F0235	229 m	4575 W	35,0 Ω	5703466202487



## DEVIbasic™ Drum Goods (DSIG)

DEVIbasic™ is an high-quality, braided screen, single conductor cable with a tough outer sheath (non UV stable). Its round profile and robust construction ensures a fast, simple and safe installation in multiple indoor, outdoor and pipe tracing applications.

To ensure a long life-time, all cables are minutely inspected including tests for Ohmic resistance, high voltage and material controls to ensure the quality.

DEVIbasic™ can be customized for the specific project, depending on voltage, required output, length of heating cable and length of cold leads.



**Note:** It is the full responsibility of the installer/designer to use proper cold lead dimensioned for the purpose and assembly sets that establish sufficient mechanical strength, flammability resistance and water tightness - and to design the heating unit with correct output for the specific application to avoid overheating of the cable or building materials.

### Benefits:

- Easy to install
- Multiple application options
- Safe and robust
- Long life-time

### Standard compliance:

- IEC60800:1992

### Approvals:



Type	Value
Operation voltage, max	U <sub>o</sub> /U = 300/500 V~
Construction	Round, single conductor with screen
Output, max	20 W/m
Max. permissible use temperature, powered	60 °C @ 20 W/m
Max. permissible use temperature, unpowered	90 °C
Cable dimensions	Ø 5,5 mm
Deformation strength	600 N
Pulling strength	120 N
Conductor insulation	XLPE
Outer sheath	PVC
Screen	16 x 0.3 mm Cu (1 mm <sup>2</sup> )
Min. installation temperature	-5 °C
Bending Ø, min.	50 mm
IP Class	IPX7

### Types

Item no.	Resistance	EAN no.
140F0165	0,0134 Ω/m	5703466228593
140F0163	0,0320 Ω/m	5703466228579
140F0166	0,0322 Ω/m	5703466228609
140F0185	0,0500 Ω/m	5703466228791
140F0167	0,0508 Ω/m	5703466228616
140F0162	0,0700 Ω/m	5703466228562
140F0168	0,0715 Ω/m	5703466228623
140F0186	0,1000 Ω/m	5703466228807
140F0169	0,1050 Ω/m	5703466228630
140F0187	0,1500 Ω/m	5703466228814
140F0170	0,1530 Ω/m	5703466228647
140F0161	0,1820 Ω/m	5703466228555
140F0188	0,2100 Ω/m	5703466228821
140F0171	0,2170 Ω/m	5703466228654
140F0172	0,2670 Ω/m	5703466228661
140F0195	0,2700 Ω/m	5703466228890
140F0173	0,3190 Ω/m	5703466228678
140F0189	0,3400 Ω/m	5703466228838
140F0196	0,4100 Ω/m	5703466228906
140F0174	0,4880 Ω/m	5703466228685

Item no.	Resistance	EAN no.
140F0190	0,5000 Ω/m	5703466228845
140F0164	0,6500 Ω/m	5703466228586
140F0175	0,6660 Ω/m	5703466228692
140F0191	0,9000 Ω/m	5703466228852
140F0176	0,9340 Ω/m	5703466228708
140F0177	1,1500 Ω/m	5703466228715
140F0192	1,2000 Ω/m	5703466228869
140F0193	1,6000 Ω/m	5703466228876
140F0178	1,7000 Ω/m	5703466228722
140F0194	2,5000 Ω/m	5703466228883
140F0179	2,5800 Ω/m	5703466228739
140F0197	3,8000 Ω/m	5703466228913
140F0180	3,9000 Ω/m	5703466228746
140F0181	5,0100 Ω/m	5703466228753
140F0198	5,9000 Ω/m	5703466228920
140F0160	7,6000 Ω/m	5703466228548
140F0182	7,8200 Ω/m	5703466228760
140F0183	12,9000 Ω/m	5703466228777
140F0184	34,1000 Ω/m	5703466228784

## DEVicomfort™ 10T (DTIR-10)







**20**  
YEAR  
WARRANTY

Product Installation Floor/Surface

DEVicomfort™ is an extremely high-quality, 360° fully screened twin conductor cable with a tough red PVC outer sheath (non UV stable). Its round profile, robust construction and low height ensures a fast, simple and safe installation which is perfect for renovating existing floors.

The cold lead is an installation cable with solid conductors ensuring fast installation. A clearly visible connection avoids accidentally installing the heated cable in the wall.

To ensure a long life-time, all cables are minutely inspected including tests for Ohmic resistance, high voltage and material controls to ensure the quality. This means that we are proud to supply our full floor extended DEVIwarranty™.

Benefits:	Type	Value
<ul style="list-style-type: none"> <li>• Fast and easy to install</li> <li>• Low height</li> <li>• Safe and robust</li> <li>• Long life-time</li> <li>• Maximum protection</li> </ul>	Operation voltage	220 - 240V~
	Construction	Round, twin conductor with 360° screening, one cold lead
	Output	10 W/m @ 230V~
	Max. permissible use temperature, powered	85 °C
	Max. permissible use temperature, unpowered	90 °C
<b>Standard compliance:</b> <ul style="list-style-type: none"> <li>• IEC 60335-1</li> <li>• IEC 60335-2-96</li> </ul> <b>Approvals:</b>     	Cable thickness	4 mm
	Deformation strength	600N
	Pulling strength	120N
	Conductor insulation	FEP
	Outer sheath	Lead free PVC
	Screen	100% coverage; alu-foil; 0,5 mm <sup>2</sup> tinned copper drain wire
	Cold lead	2,3 m DTWB, 2 x 1,0 mm <sup>2</sup> , earthed
	Min. installation temperature	-5 °C
	Bending Ø, min.	6 x cable diameter (Ø)
	IP Class	IPX7
Set with double adhesive tape	Double adhesive tape 25 mm x 50 m	

### Types set: DEVicomfort™ 10T + double adhesive tape

Item no.	Cable length	Output @ 230V~	Resistance	EAN no.
87101700	10 m	100 W	529,0 Ω	5703466162750
87101702	20 m	200 W	264,5 Ω	5703466162767
87101706	28 m	300 W	176,3 Ω	5703466162774
87101708	41 m	400 W	132,3 Ω	5703466162781
87101710	50 m	500 W	105,8 Ω	5703466162798
87101712	57 m	600 W	88,2 Ω	5703466162804
87101714	70 m	700 W	75,6 Ω	5703466162811
87101716	81 m	800 W	66,2 Ω	5703466162828
87101718	90 m	900 W	58,8 Ω	5703466162835
87101720	100 m	1000 W	52,9 Ω	5703466162842
87101722	129 m	1250 W	42,3 Ω	5703466162859
87101724	142 m	1400 W	37,8 Ω	5703466162866
87101728	170 m	1700 W	31,1 Ω	5703466162873



## DEVI<sup>™</sup>mat 70T (DTIF-70)

DEVI<sup>™</sup>mat is an extremely high-quality, 360° fully screened self-adhesive all-in-one mat with FEP insulated conductors and a red PVDF outer sheath (non UV stable). The round profile, low height (only 3.5 mm) and robust construction ensures a fast, simple and safe installation perfect for renovating existing floors.

The cold lead is an installation cable with solid conductors ensuring fast installation. A clearly visible connection avoids accidentally installing the heated cable in the wall.

To ensure a long life-time, all cables are minutely inspected including tests for Ohmic resistance, high voltage and material controls to ensure the quality. This means that we are proud to supply our full floor extended DEVIwarranty<sup>™</sup>.

**20**  
YEAR  
WARRANTY

Product    Installation    Floor/Surface

### Benefits:

- Fast and easy to install
- Self-adhesive mesh
- Low height - only 3.5 mm
- Only one cold lead
- Long life-time
- Maximum protection

### Standard compliance:

- IEC60335-2-96

### Approvals:



Type	Value
Operation voltage	220 - 240 V~
Construction	Twin conductor with 360° screening, one cold lead
Output	70 W/m <sup>2</sup> @ 230 V~
Max. permissible use temperature, powered	115 °C
Max. permissible use temperature, unpowered	120 °C
Cable dimensions	3,0 mm
Deformation strength	600 N
Pulling strength	120 N
Conductor insulation	FEP
Outer sheath	PVDF
Screen	100% coverage; alu-foil; 0,5 mm <sup>2</sup> tinned copper drain wire
Cold lead	2,3 m, DTWB, 2 x 1 mm <sup>2</sup> with screen
Min. installation temperature	-5 °C
Min. bending Ø	50 mm
IP Class	IPX7

### Types

Item no.	Output @ 230V~	Heated area	Resistance	Dimensions (W x L)	EAN no.
83020585	210 W	3,0 m <sup>2</sup>	252 Ω	0,5 x 6,0 m	5703466106457
83020588	350 W	5,0 m <sup>2</sup>	151 Ω	0,5 x 10,0 m	5703466106464
83020590	490 W	7,0 m <sup>2</sup>	108 Ω	0,5 x 14,0 m	5703466106471
83020592	615 W	8,7 m <sup>2</sup>	86 Ω	0,5 x 17,5 m	5703466106488
83020594	825 W	11,7 m <sup>2</sup>	64 Ω	0,5 x 23,5 m	5703466106495



## DEVI mat™ 100T (DTIF-100)

DEVI mat™ is an extremely high-quality, 360° fully screened self-adhesive all-in-one mat with FEP insulated conductors and a red PVDF outer sheath (non UV stable). The round profile, low height (only 3.5 mm) and robust construction ensures a fast, simple and safe installation perfect for renovating existing floors.

The cold lead is an installation cable with solid conductors ensuring fast installation. A clearly visible connection avoids accidentally installing the heated cable in the wall.

To ensure a long life-time, all cables are minutely inspected including tests for Ohmic resistance, high voltage and material controls to ensure the quality. This means that we are proud to supply our full floor extended DEVI warranty™.

**20 YEAR WARRANTY**

Product Installation Floor/Surface

### Benefits:

- Fast and easy to install
- Self-adhesive mesh
- Low height - only 3.5 mm
- Only one cold lead
- Long life-time
- Maximum protection

### Standard compliance:

- IEC60335-2-96

### Approvals:



Type	Value
Operation voltage	220 - 240 V~
Construction	Twin conductor with 360° screening, one cold lead
Output	100 W/m <sup>2</sup> @ 230 V~
Max. permissible use temperature, powered	115 °C
Max. permissible use temperature, unpowered	120 °C
Cable dimensions	3,0 mm
Deformation strength	600 N
Pulling strength	120 N
Conductor insulation	FEP
Outer sheath	PVDF
Screen	100% coverage; alu-foil; 0,5 mm <sup>2</sup> tinned copper drain wire
Cold lead	2,3 m, DTWB, 2 x 1 mm <sup>2</sup> with screen
Min. installation temperature	-5 °C
Min. bending Ø	50 mm
IP Class	IPX7

### Types

Item no.	Output @ 230V~	Heated area	Resistance	Dimensions (W x L)	EAN no.
140F0415	100 W	1,0 m <sup>2</sup>	529 Ω	0,5 x 2 m	5703466203064
140F0416	150 W	1,5 m <sup>2</sup>	353 Ω	0,5 x 3 m	5703466203071
140F0417	200 W	2,0 m <sup>2</sup>	265 Ω	0,5 x 4 m	5703466203088
140F0418	250 W	2,5 m <sup>2</sup>	212 Ω	0,5 x 5 m	5703466203095
140F0419	300 W	3,0 m <sup>2</sup>	176 Ω	0,5 x 6 m	5703466203101
140F0420	350 W	3,5 m <sup>2</sup>	151 Ω	0,5 x 7 m	5703466203118
140F0421	400 W	4,0 m <sup>2</sup>	132 Ω	0,5 x 8 m	5703466203125
140F0422	500 W	5,0 m <sup>2</sup>	106 Ω	0,5 x 10 m	5703466203132
140F0423	600 W	6,0 m <sup>2</sup>	88 Ω	0,5 x 12 m	5703466203149
140F0424	700 W	7,0 m <sup>2</sup>	76 Ω	0,5 x 14 m	5703466203156
140F0425	800 W	8,0 m <sup>2</sup>	66 Ω	0,5 x 16 m	5703466203163
140F0426	900 W	9,0 m <sup>2</sup>	59 Ω	0,5 x 18 m	5703466203170
140F0427	1000 W	10,0 m <sup>2</sup>	53 Ω	0,5 x 20 m	5703466203187
140F0428	1200 W	12,0 m <sup>2</sup>	44 Ω	0,5 x 24 m	5703466203194



## DEVI<sup>™</sup> 150T (DTIF-150)

DEVI<sup>™</sup> is an extremely high-quality, 360° fully screened self-adhesive all-in-one mat with FEP insulated conductors and a red PVDF outer sheath (non UV stable). The round profile, low height (only 3.5 mm) and robust construction ensures a fast, simple and safe installation perfect for renovating existing floors.

The cold lead is an installation cable with solid conductors ensuring fast installation. A clearly visible connection avoids accidentally installing the heated cable in the wall.

To ensure a long life-time, all cables are minutely inspected including tests for Ohmic resistance, high voltage and material controls to ensure the quality. This means that we are proud to supply our full floor extended DEVIwarranty<sup>™</sup>.

**20 YEAR WARRANTY**

Product Installation Floor/Surface

### Benefits:

- Fast and easy to install
- Self-adhesive mesh
- Low height - only 3.5 mm
- Only one cold lead
- Long life-time
- Maximum protection

### Standard compliance:

- IEC60335-2-96

### Approvals:



Type	Value
Operation voltage	220 - 240 V~
Construction	Twin conductor with 360° screening, one cold lead
Output	150 W/m <sup>2</sup> @ 230 V~
Max. permissible use temperature, powered	115 °C
Max. permissible use temperature, unpowered	120 °C
Cable dimensions	3,0 mm
Deformation strength	600 N
Pulling strength	120 N
Conductor insulation	FEP
Outer sheath	PVDF
Screen	100% coverage; alu-foil; 0,5 mm <sup>2</sup> tinned copper drain wire
Cold lead	2,3 m DTWB 2 x 1 mm <sup>2</sup> with screen
Min. installation temperature	-5 °C
Min. bending Ø	50 mm
IP Class	IPX7

### Types

Item no.	Output @ 230V~	Heated area	Resistance	Dimensions (W x L)	EAN no.
140F0444	75 W	0,5 m <sup>2</sup>	705 Ω	0,5 x 1 m	5703466203354
140F0445	150 W	1,0 m <sup>2</sup>	353 Ω	0,5 x 2 m	5703466203361
140F0446	225 W	1,5 m <sup>2</sup>	235 Ω	0,5 x 3 m	5703466203378
140F0447	300 W	2,0 m <sup>2</sup>	176 Ω	0,5 x 4 m	5703466203385
140F0448	375 W	2,5 m <sup>2</sup>	141 Ω	0,5 x 5 m	5703466203392
140F0449	450 W	3,0 m <sup>2</sup>	118 Ω	0,5 x 6 m	5703466203408
140F0450	525 W	3,5 m <sup>2</sup>	100 Ω	0,5 x 7 m	5703466203415
140F0451	600 W	4,0 m <sup>2</sup>	88 Ω	0,5 x 8 m	5703466203422
140F0452	750 W	5,0 m <sup>2</sup>	70 Ω	0,5 x 10 m	5703466203439
140F0453	900 W	6,0 m <sup>2</sup>	59 Ω	0,5 x 12 m	5703466203446
140F0454	1050 W	7,0 m <sup>2</sup>	50 Ω	0,5 x 14 m	5703466203453
140F0455	1200 W	8,0 m <sup>2</sup>	44 Ω	0,5 x 16 m	5703466203460
140F0456	1350 W	9,0 m <sup>2</sup>	40 Ω	0,5 x 18 m	5703466203477
140F0457	1500 W	10,0 m <sup>2</sup>	35 Ω	0,5 x 20 m	5703466203484
140F0458	1800 W	12,0 m <sup>2</sup>	30 Ω	0,5 x 24 m	5703466203491





## DEVI mat™ 200T (DTIF-200)

DEVI mat™ is an extremely high-quality, 360° fully screened self-adhesive all-in-one mat with FEP insulated conductors and a red PVDF outer sheath (non UV stable). The round profile, low height (only 3.5 mm) and robust construction ensures a fast, simple and safe installation perfect for renovating existing floors.

The cold lead is an installation cable with solid conductors ensuring fast installation. A clearly visible connection avoids accidentally installing the heated cable in the wall.

To ensure a long life-time, all cables are minutely inspected including tests for Ohmic resistance, high voltage and material controls to ensure the quality. This means that we are proud to supply our full floor extended DEVI warranty™.

**20 YEAR WARRANTY**

Product Installation Floor/Surface

### Benefits:

- Fast and easy to install
- Self-adhesive mesh
- Low height - only 3.5 mm
- Only one cold lead
- Long life-time
- Maximum protection

### Standard compliance:

- IEC60335-2-96

### Approvals:



Type	Value
Operation voltage	220 V - 240 V
Construction	Twin conductor with 360° screening, one cold lead
Output	200 W/m <sup>2</sup> @ 230 V~
Max. permissible use temperature, powered	115 °C
Max. permissible use temperature, unpowered	120 °C
Cable dimensions	3,0 mm
Deformation strength	600 N
Pulling strength	120 N
Conductor insulation	FEP
Outer sheath	PVDF
Screen	100% coverage; alu-foil; 0,5 mm <sup>2</sup> tinned copper drain wire
Cold lead	2,3 m DTWB 2 x 1 mm <sup>2</sup> with screen
Min. installation temperature	-5 °C
Min. bending Ø	50 mm
IP Class	IPX7

### Types

Item no.	Output @ 230V~	Heated area	Resistance	Dimensions (W x L)	EAN no.
83020735	87 W	0,5 m <sup>2</sup>	608 Ω	0,5 x 0,9 m	5703466195987
83020736	215 W	1,1 m <sup>2</sup>	246 Ω	0,5 x 2,1 m	5703466195994
83020737	285 W	1,5 m <sup>2</sup>	186 Ω	0,5 x 2,9 m	5703466196007
83020738	430 W	2,1 m <sup>2</sup>	123 Ω	0,5 x 4,2 m	5703466196014
83020739	500 W	2,5 m <sup>2</sup>	106 Ω	0,5 x 5,0 m	5703466196021
83020740	605 W	3,1 m <sup>2</sup>	87 Ω	0,5 x 6,2 m	5703466196038
83020741	695 W	3,5 m <sup>2</sup>	76 Ω	0,5 x 6,9 m	5703466196045
83020742	845 W	4,3 m <sup>2</sup>	63 Ω	0,5 x 8,6 m	5703466196052
83020743	990 W	5,0 m <sup>2</sup>	53 Ω	0,5 x 9,9 m	5703466196069
83020744	1210 W	6,1 m <sup>2</sup>	44 Ω	0,5 x 12,2 m	5703466196076
83020745	1385 W	7,0 m <sup>2</sup>	38 Ω	0,5 x 14,0 m	5703466196083
83020746	1565 W	7,8 m <sup>2</sup>	34 Ω	0,5 x 15,6 m	5703466196090
83020747	1715 W	8,8 m <sup>2</sup>	31 Ω	0,5 x 17,6 m	5703466196106
83020748	2070 W	10,5 m <sup>2</sup>	26 Ω	0,5 x 21,0 m	5703466196113



## DEVIcomfort™ 100T (DTIR-100)

DEVIcomfort™ is an extremely high-quality, 360° fully screened twin conductor self-adhesive all-in-one mat with a tough red PVC outer sheath (non UV stable). Its round profile, robust construction and low height ensures a fast, simple and safe installation which is perfect for renovating existing floors.

The cold lead is an installation cable with solid conductors ensuring fast installation. A clearly visible connection avoids accidentally installing the heated cable in the wall.

To ensure a long life-time, all cables are minutely inspected including tests for Ohmic resistance, high voltage and material controls to ensure the quality. This means that we are proud to supply our full floor extended DEVIwarranty™.

**20 YEAR WARRANTY**

Product    Installation    Floor/Surface

### Benefits:

- Fast and easy to install
- Self-adhesive mesh
- Low height
- Only one cold lead
- Long life-time
- Maximum protection

### Standard compliance:

- IEC60335-2-96

### Approvals:



Type	Value
Operation voltage	220 - 240 V~
Construction	Round, twin conductor with 360° screen, one cold lead
Output	100 W/m <sup>2</sup> @ 230 V~
Max. permissible use temperature, powered	85 °C
Max. permissible use temperature, unpowered	90 °C
Cable thickness	4 mm
Deformation strength	600 N
Pulling strength	120 N
Conductor insulation	FEP
Outer sheath	PVC
Screen	100% coverage; alu-foil; 0,5 mm <sup>2</sup> tinned copper drain wire
Cold lead	2,3 m, DTWB,, 2 x 1,0 mm <sup>2</sup> , earthed
Min. installation temperature	-5 °C
Bending Ø, min.	50 mm
IP Class	IPX7

### Types

Item no.	Output @ 230V~	Heated area	Resistance	Dimensions (W x L)	EAN no.
83030500	50 W	0,5 m <sup>2</sup>	1058,0 Ω	0,5 x 1 m	5703466162453
83030502	100 W	1,0 m <sup>2</sup>	529,0 Ω	0,5 x 2 m	5703466162460
83030504	150 W	1,5 m <sup>2</sup>	352,0 Ω	0,5 x 3 m	5703466162477
83030506	200 W	2,0 m <sup>2</sup>	264,0 Ω	0,5 x 4 m	5703466162484
83030508	250 W	2,5 m <sup>2</sup>	211,0 Ω	0,5 x 5 m	5703466162491
83030510	300 W	3,0 m <sup>2</sup>	176,0 Ω	0,5 x 6 m	5703466162507
83030512	350 W	3,5 m <sup>2</sup>	151,0 Ω	0,5 x 7 m	5703466162514
83030514	400 W	4,0 m <sup>2</sup>	132,0 Ω	0,5 x 8 m	5703466162521
83030516	500 W	5,0 m <sup>2</sup>	105,0 Ω	0,5 x 10 m	5703466162538
83030518	600 W	6,0 m <sup>2</sup>	88,1 Ω	0,5 x 12 m	5703466162545
83030520	700 W	7,0 m <sup>2</sup>	75,5 Ω	0,5 x 14 m	5703466162552
83030522	800 W	8,0 m <sup>2</sup>	66,1 Ω	0,5 x 16 m	5703466162569
83030524	900 W	9,0 m <sup>2</sup>	58,7 Ω	0,5 x 18 m	5703466162576
83030526	1000 W	10,0 m <sup>2</sup>	52,9 Ω	0,5 x 20 m	5703466162583
83030528	1200 W	12,0 m <sup>2</sup>	44,1 Ω	0,5 x 24 m	5703466162590



## DEVIcomfort™ 150T (DTIR-150)

DEVIcomfort™ is an extremely high-quality, 360° fully screened twin conductor self-adhesive all-in-one mat with a tough red PVC outer sheath (non UV stable). Its round profile, robust construction and low height ensures a fast, simple and safe installation which is perfect for renovating existing floors.

The cold lead is an installation cable with solid conductors ensuring fast installation. A clearly visible connection avoids accidentally installing the heated cable in the wall.

To ensure a long life-time, all cables are minutely inspected including tests for Ohmic resistance, high voltage and material controls to ensure the quality. This means that we are proud to supply our full floor extended DEVIwarranty™.

**20 YEAR WARRANTY**

Product Installation Floor/Surface

### Benefits:

- Fast and easy to install
- Self-adhesive mesh
- Low height
- Only one cold lead
- Long life-time
- Maximum protection

### Standard compliance:

- IEC60335-2-96

### Approvals:



Type	Value
Operation voltage	220 - 240 V~
Construction	Round, twin conductor with 360° screen, one cold lead
Output	150 W/m <sup>2</sup> @ 230 V~
Max. permissible use temperature, powered	85 °C
Max. permissible use temperature, unpowered	90 °C
Cable thickness	4 mm
Deformation strength	600 N
Pulling strength	120 N
Conductor insulation	FEP
Outer sheath	PVC
Screen	100% coverage; alu-foil; 0,5 mm <sup>2</sup> tinned copper drain wire
Cold lead	2,3 m DTWB, 2 x 1,0 mm <sup>2</sup> , earthed
Min. installation temperature	-5 °C
Bending Ø, min.	50 mm
IP Class	IPX7

### Types

Item no.	Output @ 230V~	Heated area	Resistance	Dimensions (W x L)	EAN no.
83030560	75 W	0,5 m <sup>2</sup>	705,3 Ω	0,5 x 1 m	5703466169322
83030562	150 W	1,0 m <sup>2</sup>	352,7 Ω	0,5 x 2 m	5703466169339
83030564	225 W	1,5 m <sup>2</sup>	235,1 Ω	0,5 x 3 m	5703466169346
83030566	300 W	2,0 m <sup>2</sup>	176,3 Ω	0,5 x 4 m	5703466169353
83030568	375 W	2,5 m <sup>2</sup>	141,1 Ω	0,5 x 5 m	5703466169360
83030570	450 W	3,0 m <sup>2</sup>	117,6 Ω	0,5 x 6 m	5703466169377
83030572	525 W	3,5 m <sup>2</sup>	100,8 Ω	0,5 x 7 m	5703466169384
83030574	600 W	4,0 m <sup>2</sup>	88,2 Ω	0,5 x 8 m	5703466169391
83030576	750 W	5,0 m <sup>2</sup>	70,5 Ω	0,5 x 10 m	5703466169407
83030578	900 W	6,0 m <sup>2</sup>	58,8 Ω	0,5 x 12 m	5703466169414
83030580	1050 W	7,0 m <sup>2</sup>	50,4 Ω	0,5 x 14 m	5703466169421
83030582	1200 W	8,0 m <sup>2</sup>	44,1 Ω	0,5 x 16 m	5703466169438
83030584	1350 W	9,0 m <sup>2</sup>	39,2 Ω	0,5 x 18 m	5703466169445
83030586	1500 W	10,0 m <sup>2</sup>	35,3 Ω	0,5 x 20 m	5703466169452
83030588	1800 W	12,0 m <sup>2</sup>	29,4 Ω	0,5 x 24 m	5703466169469





## DEVIheat™ 150S (DSVF-150) DEVIheat™ Mirror 150S

DEVIheat™ is a high-quality, braided screen, self-adhesive all-in-one mat with FEP insulated conductors and a red PVDF outer sheath (non UV stable). The round profile, very low height (only 2.5 mm) and robust construction ensures a fast, simple and safe installation perfect for renovating existing floors.

DEVIheat™ Mirror 150S heating mat is used for keeping the bathroom mirror mist free by mounting the heating mat in the adhesive behind the mirror.

The two cold leads have clearly visible connections to avoid accidentally installing the heated cable in the wall.

To ensure a long life-time, all cables are minutely inspected including tests for Ohmic resistance, high voltage and material controls to ensure the quality. This means that we are proud to supply our full floor extended DEVIwarranty™.

### Benefits:

- Fast and easy to install
- Self-adhesive mesh
- Very low height - only 2.5 mm
- Long life-time

### Standard compliance:

- IEC60335-2-96

### Approvals:



Type	Value
Operation voltage	220 - 240 V~
Construction	Round, single conductor with screen, two cold leads
Output	150 W/m <sup>2</sup> @ 230 V~
Max. permissible use temperature, powered	110 °C
Max. permissible use temperature, unpowered	120 °C
Cable thickness	2.5 mm
Deformation strength	600 N
Pulling strength	120 N
Conductor insulation	FEP
Outer sheath	PVDF
Screen	10 x CU threads
Cold lead	2 x 3 m, DSWB, 1 x 1,0 mm <sup>2</sup> , earthed
Min. installation temperature	-5 °C
Bending Ø, min.	50 mm
IP Class	IPX7

### Types DEVIheat™ 150S

Item no.	Output @ 230V~	Dimensions (W x L)	Heated area	Resistance	EAN no.
140F0328	75 W	0,5 x 1 m	0,5 m <sup>2</sup>	705 Ω	5703466202777
140F0329	150 W	0,5 x 2 m	1,0 m <sup>2</sup>	353 Ω	5703466202784
140F0330	225 W	0,5 x 3 m	1,5 m <sup>2</sup>	235 Ω	5703466202791
140F0331	300 W	0,5 x 4 m	2,0 m <sup>2</sup>	176 Ω	5703466202807
140F0332	375 W	0,5 x 5 m	2,5 m <sup>2</sup>	141 Ω	5703466202814
140F0333	450 W	0,5 x 6 m	3,0 m <sup>2</sup>	118 Ω	5703466202821
140F0334	525 W	0,5 x 7 m	3,5 m <sup>2</sup>	101 Ω	5703466202838
140F0335	600 W	0,5 x 8 m	4,0 m <sup>2</sup>	88 Ω	5703466202845
140F0336	750 W	0,5 x 10 m	5,0 m <sup>2</sup>	74 Ω	5703466202852
140F0338	900 W	0,5 x 12 m	6,0 m <sup>2</sup>	59 Ω	5703466202876
140F0339	1050 W	0,5 x 14 m	7,0 m <sup>2</sup>	50 Ω	5703466202883
140F0340	1200 W	0,5 x 16 m	8,0 m <sup>2</sup>	44 Ω	5703466202890
140F0337	1350 W	0,5 x 18 m	9,0 m <sup>2</sup>	39 Ω	5703466202869
140F0341	1500 W	0,5 x 20 m	10,0 m <sup>2</sup>	35 Ω	5703466202906

### Types DEVIheat™ Mirror 150S

Item no.	Output @ 230V~	Dimensions (W x L)	Heated area	Resistance	EAN no.
83000301	50 W	0,5 x 0,7 m	0,35 m <sup>2</sup>	1010 Ω	5703466083697
83000300	75 W	0,6 x 0,8 m	0,48 m <sup>2</sup>	686 Ω	5703466056660



**20**  
YEAR  
WARRANTY

Product Installation Floor/Surface

## DTCE 100T (DTCE-100)

DTCE is an extremely high-quality, 360° fully screened twin conductor heating mat with a tough outer sheath (UV stable). Its round profile and robust construction ensures a fast, simple and safe installation in floors where the heating cable is embedded in concrete. The cold lead has solid conductors ensuring fast installation with a clearly visible connection.

To ensure a long life-time, all cables are minutely inspected including tests for Ohmic resistance, high voltage and material controls to ensure the quality. This means that we are proud to supply our extended DEVIwarranty™.

**Note.** DTCE heating mat is not approved for installation on roof because the fixing tape is not UV-stable.

### Benefits:

- Fast and easy to install
- Safe and robust
- Long life-time
- Maximum protection
- UV stable

### Standard compliance:

- IEC60800:2009

### Approvals:



Type	Value
Operation voltage	220 - 240 V~
Construction	Round, twin conductor with 360° screening, one cold lead
Output	100 W/m <sup>2</sup> @ 230 V~
Max. permissible use temperature, powered	75 °C
Max. permissible use temperature, unpowered	90 °C
Cable thickness	7 mm
Deformation strength	>1500 N
Pulling strength	>300 N
Conductor insulation	FEP
Outer sheath	UV protected PVC
Screen	0.5 mm <sup>2</sup> Cu, 100% Alu-foil
Cold lead	6 m DTWC, 2 x 1.5 mm <sup>2</sup> , earthed
Min. installation temperature	-5 °C
Bending Ø, min.	50 mm
IP Class	IPX7

### Types

Item no.	Output @ 230V~	Dimensions (W x L)	Area	Resistance	EAN no.
83901900	235 W	0,75 m x 3,0 m	2,25 m <sup>2</sup>	225,1 Ω	5703466158210
83901903	350 W	0,75 m x 4,8 m	3,60 m <sup>2</sup>	151,1 Ω	5703466158227
83901906	465 W	0,75 m x 6,4 m	4,80 m <sup>2</sup>	113,8 Ω	5703466158234
83901909	580 W	0,75 m x 8,0 m	6,00 m <sup>2</sup>	91,2 Ω	5703466158241
83901912	840 W	0,75 m x 11,4 m	8,60 m <sup>2</sup>	63,0 Ω	5703466158258
83901915	1115 W	0,75 m x 14,0 m	10,50 m <sup>2</sup>	47,4 Ω	5703466158265
83901918	1200 W	0,75 m x 16,0 m	12,00 m <sup>2</sup>	44,1 Ω	5703466158272





**20**  
YEAR  
WARRANTY

Product Installation Floor/Surface





## DTCE 150T (DTCE-150)

DTCE is an extremely high-quality, 360° fully screened twin conductor heating mat with a tough outer sheath (UV stable). Its round profile and robust construction ensures a fast, simple and safe installation in floors where the heating cable is embedded in concrete.

The cold lead has solid conductors ensuring fast installation with a clearly visible connection.

To ensure a long life-time, all cables are minutely inspected including tests for Ohmic resistance, high voltage and material controls to ensure the quality. This means that we are proud to supply our extended DEVIwarranty™.

**Note.** DTCE heating mat is not approved for installation on roof because the fixing tape is not UV-stable.

Benefits:	Type	Value
<ul style="list-style-type: none"> <li>• Fast and easy to install</li> <li>• Safe and robust</li> <li>• Long life-time</li> <li>• Maximum protection</li> <li>• UV stable</li> </ul>	Operation voltage	220 - 240 V~
	Construction	Round, twin conductor with 360° screening, one cold lead
	Output	150 W/m <sup>2</sup> @ 230 V~
	Max. permissible use temperature, powered	80 °C
	Max. permissible use temperature, unpowered	90 °C
<b>Standard compliance:</b> <ul style="list-style-type: none"> <li>• IEC60800:2009</li> </ul> <b>Approvals:</b>     	Cable thickness	7 mm
	Deformation strength	>1500 N
	Pulling strength	>300 N
	Conductor insulation	FEP
	Outer sheath	UV protected PVC
	Screen	0,5 mm <sup>2</sup> Cu, 100% Alu-foil
	Cold lead	6 m DTWC, 2 x 1,5 mm <sup>2</sup> , earthed
	Min. installation temperature	-5 °C
	Bending Ø, min.	50 mm
	IP Class	IPX7

### Types

Item no.	Output @ 230V~	Dimensions (W x L)	Area	Resistance	EAN no.
83901921	290 W	0,75 m x 2,6 m	2,0 m <sup>2</sup>	182,4 Ω	5703466158289
83901924	440 W	0,75 m x 3,8 m	2,9 m <sup>2</sup>	120,2 Ω	5703466158296
83901927	575 W	0,75 m x 5,2 m	3,9 m <sup>2</sup>	92,8 Ω	5703466158302
83901930	720 W	0,75 m x 6,4 m	4,8 m <sup>2</sup>	73,5 Ω	5703466158319
83901933	1040 W	0,75 m x 9,2 m	6,9 m <sup>2</sup>	50,9 Ω	5703466158326
83901936	1450 W	0,75 m x 13,2 m	9,9 m <sup>2</sup>	36,5 Ω	5703466158333
83901939	1730 W	0,75 m x 15,8 m	11,9 m <sup>2</sup>	30,6 Ω	5703466158340



## DTCE 175T (DTCE-175)

DTCE is an extremely high-quality, 360° fully screened twin conductor heating mat with a tough outer sheath (UV stable). Its round profile and robust construction ensures a fast, simple and safe installation in floors where the heating cable is embedded in concrete.

The cold lead has solid conductors ensuring fast installation with a clearly visible connection.

To ensure a long life-time, all cables are minutely inspected including tests for Ohmic resistance, high voltage and material controls to ensure the quality. This means that we are proud to supply our extended DEVIwarranty™.

**Note.** DTCE heating mat is not approved for installation on roof because the fixing tape is not UV-stable.

**20**  
YEAR  
WARRANTY

Product    Installation    Floor/Surface

### Benefits:

- Fast and easy to install
- Safe and robust
- Long life-time
- Maximum protection
- UV stable

### Standard compliance:

- IEC60800:2009

### Approvals:



Type	Value
Operation voltage	220 - 240 V~
Construction	Round, twin conductor with 360° screening, one cold lead
Output	175 W/m <sup>2</sup> @ 230 V~
Max. permissible use temperature, powered	80 °C
Max. permissible use temperature, unpowered	90 °C
Cable thickness	7 mm
Deformation strength	>1500 N
Pulling strength	>300 N
Conductor insulation	FEP
Outer sheath	UV protected PVC
Screen	0,5 mm <sup>2</sup> Cu, 100% Alu-foil
Cold lead	6 m DTWC, 2 x 1,5 mm <sup>2</sup> , earthed
Min. installation temperature	-5 °C
Bending Ø, min.	50 mm
IP Class	IPX7

### Types

Item no.	Dimensions (W x L)	Area	Output @ 230V~	Resistance	EAN no.
83901942	0,75 x 1,5 m	1,1 m <sup>2</sup>	195 W	271,3 Ω	5703466158432
83901945	0,75 x 2,1 m	1,6 m <sup>2</sup>	265 W	199,6 Ω	5703466158449
83901948	0,75 x 4 m	3,0 m <sup>2</sup>	540 W	98,6 Ω	5703466158456
83901949	0,75 x 5,1 m	3,8 m <sup>2</sup>	680 W	77,8 Ω	5703466169995
83901951	0,75 x 6,75 m	5,1 m <sup>2</sup>	890 W	59,4 Ω	5703466158463
83901954	0,75 x 9,45 m	7,1 m <sup>2</sup>	1230 W	43,0 Ω	5703466158470
83901957	0,75 x 11,7 m	8,8 m <sup>2</sup>	1550 W	34,1 Ω	5703466158487
83901960	0,75 x 16,6 m	12,5 m <sup>2</sup>	2165 W	24,4 Ω	5703466158494
83901963	0,75 x 20,8 m	15,6 m <sup>2</sup>	2750 W	19,2 Ω	5703466158500



**20 YEAR WARRANTY**

Product Installation Floor/Surface

## DTCE 200T

DTCE is an extremely high-quality, 360° fully screened twin conductor heating mat with a tough outer sheath (UV stable). Its round profile and robust construction ensures a fast, simple and safe installation in floors where the heating cable is embedded in concrete.

The cold lead has solid conductors ensuring fast installation with a clearly visible connection.

To ensure a long life-time, all cables are minutely inspected including tests for Ohmic resistance, high voltage and material controls to ensure the quality. This means that we are proud to supply our extended DEVIwarranty™.

**Note.** DTCE heating mat is not approved for installation on roof because the fixing tape is not UV-stable.

### Benefits:

- Fast and easy to install
- Multiple outdoor applications
- Safe and robust
- Long life-time
- Maximum protection
- UV stable

### Standard compliance:

- IEC60800:2009

### Approvals:



Type	Value
Operation voltage	220 - 240V~
Construction	Round, twin conductor with 360° screening, one cold lead
Output	300 W/m <sup>2</sup>
Max. permissible use temperature, powered	60 °C
Max. permissible use temperature, unpowered	90 °C
Cable thickness	7 mm
Deformation strength	>2000 N
Pulling strength	>120 N
Conductor insulation	FEP
Outer sheath	PVC
Screen	100% coverage; alu-foil; 0,5 mm <sup>2</sup> tinned copper drain wire
Cold lead	10 m DTWC, earthed
Min. installation temperature	-5°C
Bending Ø	50 mm
IP Class	IPX7

### Types

Item no.	Output @ 230V~	Di mensions (W x L)	Area	Resistance	EAN no.
83901965	220 W	0,75 m x 1,35 m	1,0 m <sup>2</sup>	240,5 Ω	5703466170007
83901966	285 W	0,75 m x 1,95 m	1,5 m <sup>2</sup>	185,6 Ω	5703466158357
83901969	575 W	0,75 m x 3,90 m	2,9 m <sup>2</sup>	92,8 Ω	5703466158364
83901970	720 W	0,75 m x 4,80 m	3,6 m <sup>2</sup>	73,5 Ω	5703466170014
83901972	940 W	0,75 m x 6,45 m	4,8 m <sup>2</sup>	56,3 Ω	5703466158371
83901975	1175 W	0,75 m x 7,95 m	6,0 m <sup>2</sup>	45,2 Ω	5703466158388
83901978	1435 W	0,75 m x 10,05 m	7,5 m <sup>2</sup>	37,0 Ω	5703466158395
83901981	1715 W	0,75 m x 12,00 m	9,0 m <sup>2</sup>	30,8 Ω	5703466158401
83901984	2280 W	0,75 m x 15,90 m	11,9 m <sup>2</sup>	23,2 Ω	5703466158418
83901987	2900 W	0,75 m x 19,80 m	14,9 m <sup>2</sup>	18,2 Ω	5703466158425



## DEVIDry™ Heating Element 55 W/m<sup>2</sup>



DEVIDry™ is a floor heating system consisting of a foam construction only 8 mm high with heating elements inside.

This all-in-one heating element and underlay system can be used under wooden floorings, parquets and laminates up to 22 mm (and even carpets with DEVIDry™ Plug Kit). The system has been tested with flooring materials with insulation values from 0,05 to 0,18 m<sup>2</sup> K/W.

To ensure a long life-time, all heating elements are minutely inspected including tests for Ohmic resistance, high voltage and material controls to ensure the quality.

Benefits:	Type	V alue
<ul style="list-style-type: none"> <li>• Easy and simple installation</li> <li>• No screed needed</li> <li>• Fast responding</li> <li>• Noise reduction up to 17 dB.</li> <li>• Low building height</li> </ul>	Operation voltage	220 - 240 V
	Output	55 W/m <sup>2</sup> @ 230 V~
	Height	8 mm
	Max. amps per DEVIDry™ system	10 A
	Insulation value (μ)	8 W/m <sup>2</sup> K
	Sound reduction value	17 db
	IP class	X7
<b>Standard compliance:</b>	Point load	>2000 N
<ul style="list-style-type: none"> <li>• IEC 60335-2-96 (with DEVIDry™ Pro Kit)</li> <li>• IEC60335-2-106 (with DEVIDry™ Plug Kit)</li> </ul>		
<b>Approvals:</b>		
  		

### Types

Item no.	Type	Heated area	Net output	EAN no.
89300000	DEVIDry™ 55, 1 m <sup>2</sup>	0.4 m <sup>2</sup>	22 W	5703466177815
89300002	DEVIDry™ 55, 2 m <sup>2</sup>	1.4 m <sup>2</sup>	77 W	5703466177822
89300004	DEVIDry™ 55, 3 m <sup>2</sup>	2.4 m <sup>2</sup>	132 W	5703466177839
89300006	DEVIDry™ 55, 4 m <sup>2</sup>	3.4 m <sup>2</sup>	187 W	5703466177846
89300008	DEVIDry™ 55, 5 m <sup>2</sup>	4.4 m <sup>2</sup>	242 W	5703466177853

### Accessories

Item no.	Product name	Description	EAN no.
89300030	DEVIDry™ FM1	Filler material, 1 m <sup>2</sup>	5703466179352
89300031	DEVIDry™ FM2	Filler material, 2 m <sup>2</sup>	5703466179369
89300032	DEVIDry™ FM4	Filler material, 4 m <sup>2</sup>	5703466179376
19911110	DEVIDry™ X25	Extension cord, 25 cm	5703466177945
19911111	DEVIDry™ X100	Extension cord, 100 cm	5703466177952
19911112	DEVIDry™ X200	Extension cord, 200 cm	5703466177969
19405856	DEVIDry™ Tape	For fixating elements	5703466190678

Output	Subfloor		Top floor		
	Wood	Concrete	Wood	Laminate	Carpet
55 W/m <sup>2</sup>	+	+	+	+	+

## DEVIDry™ Heating Element 100 W/m<sup>2</sup>



DEVIDry™ is a floor heating system consisting of a foam construction only 8 mm high with heating elements inside.

This all-in-one heating element and underlay system can be used under wooden floorings, parquets and laminates up to 22 mm (and even carpets with DEVIDry™ Plug Kit). The system has been tested with flooring materials with insulation values from 0,05 to 0,18 m<sup>2</sup> K/W.

To ensure a long life-time, all heating elements are minutely inspected including tests for Ohmic resistance, high voltage and material controls to ensure the quality.

<b>Benefits:</b> <ul style="list-style-type: none"> <li>• Easy and simple installation</li> <li>• No screed needed</li> <li>• Fast responding</li> <li>• Noise reduction up to 17 dB.</li> <li>• Low building height</li> </ul> <b>Standard compliance:</b> <ul style="list-style-type: none"> <li>• IEC 60335-2-96 (with DEVIDry™ Pro Kit)</li> <li>• IEC60335-2-106 (with DEVIDry™ Plug Kit)</li> </ul> <b>Approvals:</b> 	Type	V value
	Operation voltage	220 - 240 V
	Output	100 W/m <sup>2</sup> @ 230 V~ on concrete subfloors
	Height	8 mm
	Max. amps per DEVIDry™ system	10 A
	Insulation value (μ)	8 W/m <sup>2</sup> K
	Sound reduction value	17 db
	IP class	X7
	Point load	>2000 N

### Types

Item no.	Type	Heated area	Net output	EAN no.
89300020	DEVIDry™ 100, 1 m <sup>2</sup>	0,4 m <sup>2</sup>	40 W	5703466177860
89300022	DEVIDry™ 100, 2 m <sup>2</sup>	1,4 m <sup>2</sup>	140 W	5703466177877
89300024	DEVIDry™ 100, 3 m <sup>2</sup>	2,4 m <sup>2</sup>	240 W	5703466177884
89300026	DEVIDry™ 100, 4 m <sup>2</sup>	3,4 m <sup>2</sup>	340 W	5703466177891
89300028	DEVIDry™ 100, 5 m <sup>2</sup>	4,4 m <sup>2</sup>	440 W	5703466177907

### Accessories

Item no.	Product name	Description	EAN no.
89300030	DEVIDry™ FM1	Filler material, 1 m <sup>2</sup>	5703466179352
89300031	DEVIDry™ FM2	Filler material, 2 m <sup>2</sup>	5703466179369
89300032	DEVIDry™ FM4	Filler material, 4 m <sup>2</sup>	5703466179376
19911110	DEVIDry™ X25	Extension cord, 25 cm	5703466177945
19911111	DEVIDry™ X100	Extension cord, 100 cm	5703466177952
19911112	DEVIDry™ X200	Extension cord, 200 cm	5703466177969
19405856	DEVIDry™ Tape	For fixating elements	5703466190678

Output	Subfloor		Top floor		
	Wood	Concrete	Wood	Laminate	Carpet
100 W/m <sup>2</sup>	-	+	+	+	+



## DEVIdry™ Kit 55

The DEVIdry™ Plug Kit is used to control the DEVIdry™ floor heating system designed for floor heating in dry rooms under wooden floorings, parquets, laminates and carpets.

The kit consists of the thermostat, the Circuit Device, the NTC Floor Sensor, the Supply Cord, the Power Supply Cord, The Connection Tool and aluminium Tape.

### Benefits:

- All-in-the-box
- Easy installation
- Built-in 10A fuse
- Plug

### Standard compliance:

- EN/IEC 60335-106 (with DEVIdry™)

Type	DEVIdry™ Plug Thermostat	DEVIdry™ CD, Circuit Device
Operation voltage	220V - 240 V	220V - 240 V
Standby power consumption	Max. 0,3 W	-
Relay:		
Resistive load	"No switching"	10A / 2300W @ 230 V
Sensing unit		NTC 15 kOhm at 25°C, 3 m
Regulation	n/a	±1 °C
Ambient temperature	0 °C to 45 °C	0 °C to 45 °C
Frost protection	5 °C	5 °C
Storage temperature	-20 °C to 55 °C	-20 °C to 60 °C
Ball pressure test temperature	75 °C	75 °C
Pollution degree	2 (Domestic use)	2 (Domestic use)
Controller type	1 C	-
Software class	A	A
Temp. display and setting unit	1°C. / step	n/a
IP class	30	30
Transmission frequency	868,199 - 869,999 mHz	868,199 - 869,999 mHz
Weight	390 g	390 g
Dimensions	78 x 120 x 30 mm	92 x 85 x 40 mm

### Types

Item no.	Product name	Type	Temperature range	EAN no.
19911000	<b>DEVIdry™ Plug Kit</b>	55W	5 °C to 30 °C	5703466177914

### Accessories

Item no.	Product name	Type	EAN no.
19911100	<b>DEVIdry™ CD, Circuit Device</b>	Relay Box, 10 A	5703466177938

Output	Subfloor		Top floor		
	Wood	Concrete	Wood	Laminate	Carpet
55 W/m <sup>2</sup>	+	+	+	+	+

**Note:** Using a laminate top floor requires a minimum thickness / quality of 10 mm HDF (>800 kg / m<sup>3</sup>).

The DEVIdry™ Kit 55 is supplied with an EU Schuko mains plug.





## DEVIdry™ Kit 100

The DEVIdry™ Plug Kit is used to control the DEVIdry™ floor heating system designed for floor heating in dry rooms under wooden floorings, parquets, laminates and carpets.

The kit consists of the thermostat, the Circuit Device, the NTC Floor Sensor, the Supply Cord, the Power Supply Cord, the Connection Tool and aluminium Tape.

### Benefits:

- All-in-the-box
- Easy installation
- Built-in 10A fuse
- Plug

### Standard compliance:

- IEC 60335-106 (with DEVIdry™)

Type	DEVIdry™ Plug Thermostat	DEVIdry™ CD, Circuit Device
Operation voltage	220V - 240 V	220V - 240 V
Standby power consumption	Max. 0,3 W	-
Relay:		
Resistive load	"No switching"	10A / 2300W @ 230 V
Sensing unit		NTC 15 kOhm at 25 °C, 3 m
Regulation	n/a	±1 °C
Ambient temperature	0 °C to 45 °C	0 °C to 45 °C
Frost protection	5°C	5°C
Storage temperature	-20 °C to 55 °C	-20 °C to 60 °C
Ball pressure test temperature	75 °C	75 °C
Pollution degree	2 (Domestic use)	2 (Domestic use)
Controller type	1 C	-
Software class	A	A
Temp. display and setting unit	1 °C / step	n/a
IP class	30	30
Transmission frequency	868.199 - 869.999 MHz	868.199 - 869.999 MHz
Weight	390 g	390 g
Dimensions	78 x 120 x 30 mm	92 x 85 x 40 mm

### Types

Item no.	Product name	Type	Temperature range	EAN no.
19911001	<b>DEVIdry™ Plug Kit</b>	100W	5 °C to 35 °C	5703466177921

### Accessories

Item no.	Product name	Type	EAN no.
19911100	<b>DEVIdry™ CD, Circuit Device</b>	Relay Box, 10 A	5703466177938

Output	Subfloor		Top floor		
	Wood	Concrete	Wood	Laminate	Carpet
100 W/m <sup>2</sup>	-	+	+	+	+

**Note:** Using a laminate top floor requires a minimum thickness / quality of 10 mm HDF (>800 kg / m<sup>3</sup>).

The DEVIdry™ Kit 100 is supplied with an EU Schuko mains plug.



## DEVIdry™ Pro Kit

The DEVIdry™ Pro Kit is used to control the DEVIdry™ floor heating system designed for floor heating in dry rooms under wooden floorings, parquets, laminates and carpets.

The kit consists of the DEVIreg™ Touch thermostat, the Circuit Device, the NTC Floor Sensor, the Supply Cord, the Power Supply Cord, the Connection Tool and aluminium Tape.



### Benefits:

- All-in-the-box
- Easy installation
- Digital timer thermostat
- Low standby consumption
- Childproof function

### Standard compliance:

- EN/IEC 60335-106 (with DEVIdry™)
- EN/IEC 60730-1 (general)
- EN/IEC 60730-2-7 (timer)
- EN/IEC 60730-2-9 (thermostat)

Type	DEVIreg™ Touch
Operation voltage	220 - 240 V~ 50/60 Hz
Standby power consumption	max. 0,40 W
Resistive load	16A, 3680 W @ 230 V
Inductive load	Max. 1 A, cos φ = 0,3
Sensing unit	NTC 15 kΩ @ 25 °C
Ambient temperature	0 °C to 30 °C
Frost protection	5°C to 9°C (default 5°C )
Temperature range	5 °C to 35°C (room) 5 °C to 45 °C (floor)
Cable specification max	1 x 4 mm <sup>2</sup> or 2 x 2,5 mm <sup>2</sup>
Ball pressure test temperature	75 °C
Pollution degree	2 (domestic use)
Controller type	1 C
Storage temperature	-20°C to +65°C
IP class	21
Protection class	Class II - <input type="checkbox"/>
Dimensions (H/W/D)	85 x 85 x 20-24 mm (in-wall depth: 22 mm)
Weight	115 g

### Types

Item no.	Product name	Type	EAN no.
19911006	DEVIdry™ Pro Kit	With DEVIreg™ Touch timer	5703466194515

### Accessories

Item no.	Product name	Type	EAN no.
19911009	Supply cord	3 m, 1 mm <sup>2</sup> , max. 10 A	5703466197301

Output	Subfloor		Top floor		
	Wood	Concrete	Wood	Laminate	Carpet
55 W/m <sup>2</sup>	+	+	+	+	+
100 W/m <sup>2</sup>	-	+	+	+	-



## DEVIcell™

DEVIcell™ is an energy-efficient system, which provides up to 20% extra energy saving through integrated thermal insulation. DEVIcell™ Insulation plate covered with aluminum and readymade grooves for easy and fast installation of DEVIflex™ heating cables. The full covering aluminum effect ensures faster reaction time and an even heat distribution for the top floor.

DEVIcell™ a special system for new floor installed on top of all existing floors or sub floors. The system can be installed on the existing tiles, wooden floors or concrete floors. The system can be used under nearly all types of floor surfaces. In case of “wet” installation - the glue and primer, must be suitable for installation of tiles onto an aluminum plate and confirmed by supplier of adhesives.

DEVIcell™ system under laminate, wooden or parquet floors – DEVIcell™ & DEVIflex™ must not be embedded in concrete or similar “wet” material, Dry installation only.

DEVIcell™ system under tiles floors – “wet” installation with special tiles adhesive should be used for tile installation. Tile glue and primer, must be suitable for installation of tiles onto an aluminum plate and confirmed by producer for this application.

### Benefits:

- Sturdy construction
- No mason work with screed
- Fits DEVIflex™ (DTIP)
- Fits odd corners
- Reduced downward heat loss
- Even temperature distribution
- Quick response time with timer
- Noise reduction -3 dB

Type	V alue
Construction	Polystyrene with aluminium
R value	0,26 m <sup>2</sup> K/W
Plate size	50 x 100 cm
Thickness	13 mm
Aluminium thickness	0,8 mm
Insulation	12 mm fire retardant EPS
Deformation strength	180 kPa at 10% compression
Max working temp	80 °C
Usage of cable	5 metres per plate
Noise reduction	-3 dB

### Heat density [W/m<sup>2</sup>]

CC-distance [cm]	DEVIflex™ 6	DEVIflex™ 10
10	60 W/m <sup>2</sup>	100 W/m <sup>2</sup>
20	-	50 W/m <sup>2</sup>

### Types

Item no.	Type	No. of plates	EAN no.
140F1131	DEVIcell™, 2 m <sup>2</sup> package	4 plates	5703466179895
140F1130	DEVIcell™, 5 m <sup>2</sup> package	10 plates	5703466179888
140F1132	DEVIcell™, 50 m <sup>2</sup> pallet	100 plates	5703466179901

### Accessories

Item no.	Description	EAN no.
18055300	Mounting set for sensor	5703466128893
19805076	Aluminium tape 38 mm x 50 m, to ensure cable contact in cavities	5703466128923

This product contains a substance included on the candidate list according to article 59 (1,10) of regulation EC No. 1907/2006 ('REACH') in a concentration above 0,1% w/w: flameproofing agent, hexabromocyclododecane. HBCD is also present on the Annex 14 list.

## DEVIpipeline™ 10 (DPH-10) (B)



The DEVIpipeline™ 10 w/plug is a self-limiting heating cable that is mainly used for frost protection of pipes.

The self-limiting capability of the cable ensures that the output of the cable increase or decrease according to ambient temperature.

The heating cables can be installed inside or outside pipes. The product range: drum cable, cable with cold lead without mains plug and cable with cold lead with an EU Schuko mains plug.

### Benefits:

- Cut to length on site
- Ready made lengths
- Can be installed inside pipes

### Standard compliance:

- IEC 60335-1:2012
- IEC 62233:2008

### Approvals:



Type	Value
Operation voltage	230 V~
Output (min-max)	10 W/m @ 10 °C (8,5-13,5 W/m @ 10 °C)
Max. permissible use temperature, powered	65 °C
Max. permissible use temperature, unpowered	85 °C
Minimum use temperature	- 30 °C
Heating cable dimensions	7,7 mm x 5,3 mm
Outer sheath	Blue, TPE
Minimum Screen Coverage	100% aluminium foil
Maximum resistance protective braid	18,2 Ω/Km
Bending Ø, min.	50 mm (Ø to the inside of the cable)
Cold tail with plug	1,5 m, 3 x 1 mm <sup>2</sup> , Schuko plug
Max. installation length on a pipe with 10 A circuit breaker with C-characteristic	100 m (60 m inside the water pipe) 96 m 77 m

### Types

Item no.	Type	Length	Min-max length per drum	Number of length allowed on drum, max	Output @ 10 °C	EAN no.
98300016	DEVIpipeline™ 10	Drum, 100 m	100 m	1	10 W/m	5703466217771
98300015	DEVIpipeline™ 10	Drum, 270 m	270-330 m	1	10 W/m	5703466217764
98300017	DEVIpipeline™ 10	Drum, 900 m	900-1100 m	2, between 100 & 1100 m	10 W/m	5703466217788
140F0711	DEVIpipeline™ 10 no plug	2 m	-	-	20 W	5703466218143
140F0712	DEVIpipeline™ 10 no plug	4 m	-	-	40 W	5703466218150
140F0713	DEVIpipeline™ 10 no plug	6 m	-	-	60 W	5703466218167
140F0714	DEVIpipeline™ 10 no plug	8 m	-	-	80 W	5703466218174
140F0715	DEVIpipeline™ 10 no plug	10 m	-	-	100 W	5703466218181
140F0716	DEVIpipeline™ 10 no plug	12 m	-	-	120 W	5703466218198
140F0717	DEVIpipeline™ 10 no plug	14 m	-	-	140 W	5703466218204
140F0718	DEVIpipeline™ 10 no plug	16 m	-	-	160 W	5703466218211
140F0719	DEVIpipeline™ 10 no plug	19 m	-	-	190 W	5703466218228
140F0720	DEVIpipeline™ 10 no plug	22 m	-	-	220 W	5703466218235
140F0721	DEVIpipeline™ 10 no plug	25 m	-	-	250 W	5703466218242
98300071	DEVIpipeline™ 10 with plug	2 m	-	-	20 W	5703466217924
98300072	DEVIpipeline™ 10 with plug	4 m	-	-	40 W	5703466217931
98300073	DEVIpipeline™ 10 with plug	6 m	-	-	60 W	5703466217948
98300074	DEVIpipeline™ 10 with plug	8 m	-	-	80 W	5703466217955
98300075	DEVIpipeline™ 10 with plug	10 m	-	-	100 W	5703466217962
98300076	DEVIpipeline™ 10 with plug	12 m	-	-	120 W	5703466217979
98300077	DEVIpipeline™ 10 with plug	14 m	-	-	140 W	5703466217986
98300078	DEVIpipeline™ 10 with plug	16 m	-	-	160 W	5703466217993
98300079	DEVIpipeline™ 10 with plug	19 m	-	-	190 W	5703466218006
98300080	DEVIpipeline™ 10 with plug	22 m	-	-	220 W	5703466218013
98300081	DEVIpipeline™ 10 with plug	25 m	-	-	250 W	5703466218020
19805366	¾" + 1" Pipe fitting for DEVIpipeline™ 10 (DPH-10)				With rubber conic sliced sleeve, oval hole	5703435041697



## DEVlaqua™ 9T

**NEW**

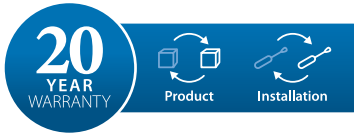

The DEVlaqua™ 9T is a light blue, high-quality, round, series resistive, full screened, twin conductor heating cable with a tough outer sheath and with a special 3/4" and 1" pipe fitting. It is approved for use in contact with drinking water up to 23 °C.

The DEVlaqua™ 9T is a heating cable developed for being installed inside drinking water pipes with the purpose to prevent frozen pipes (not for keeping water hot in pipes).

The DEVlaqua™ 9T is designed with output of 9 W/m at 230 V, as it has been evaluated to give a good balance between needed output and long-term use of the product.

The heating cable is supplied in readymade lengths with a 3/4" and 1" fitting to establish a water tight entrance for the heating cable into the drinking water pipe. It is equipped with a UV stable cold lead with solid conductors ensuring fast installation with a clearly visible connection.

### Benefits:

- Frost protection inside water pipes
- Approved for drinking water
- GDV certificate
- Readymade with cold tail
- Wide range up to 150 m
- 3/4" and 1" pipe fitting
- Safe and robust
- Long life-time

### Standard compliance:

- IEC 60800:2009

### Approvals:



Type	Value
Nominal voltage	230 V~
Construction	Round, series resistive, twin conductor with 360° screen, one cold lead
Output	9 W/m @ 230 V~
Max. water pressure	10 Bar
Max. water temperature	23 °C
Cable dimensions	Ø 7 mm
Deformation strength	>600 N
Pulling strength	>120 N
Conductor insulation	XLPE
Outer sheath	Light blue, MDPE
Screen	Alu-foil 100% coverage + 0,5 mm <sup>2</sup> tinned copper drain wire
Cold lead	2,3 m, 3x1,5 mm <sup>2</sup> , DTCL, UV-resistant
Min. installation temperature	-5 °C
Bending Ø, min.	50 mm
IP Class	IPX7

### Types

Item no.	Output @ 230 V~	Cable length	Resistance	EAN no.
140F0000	25 W	3 m	2116,0 Ω	5703466201534
140F0001	45 W	5 m	1175,6 Ω	5703466201541
140F0002	65 W	7 m	813,8 Ω	5703466201558
140F0003	90 W	10 m	587,8 Ω	5703466201565
140F0004	110 W	12 m	480,9 Ω	5703466201572
140F0005	135 W	15 m	391,9 Ω	5703466201589
140F0006	180 W	20 m	293,9 Ω	5703466201596
140F0007	225 W	25 m	235,1 Ω	5703466201602
140F0008	270 W	30 m	195,9 Ω	5703466201619
140F0009	315 W	35 m	167,9 Ω	5703466201626
140F0010	360 W	40 m	146,9 Ω	5703466201633
140F0011	450 W	50 m	117,6 Ω	5703466201640
140F0012	540 W	60 m	98,0 Ω	5703466201657
140F0013	630 W	70 m	84,0 Ω	5703466201664
140F0014	720 W	80 m	73,5 Ω	5703466201671
140F0015	810 W	90 m	65,3 Ω	5703466201688
140F0016	900 W	100 m	58,7 Ω	5703466201695
140F0017	990 W	110 m	53,4 Ω	5703466201701
140F0018	1080 W	120 m	49,0 Ω	5703466201718
140F0019	1170 W	130 m	45,2 Ω	5703466201725
140F0020	1260 W	140 m	42,0 Ω	5703466201732
140F0021	1350 W	150 m	39,2 Ω	5703466201749
19805372	3/4" + 1" Pipe fitting for blue DEVlaqua™ 9T	With rubber conic sleeve, round hole.		5703466164624

### Note!

DEVlaqua™ 9T is only for use when installed in a pipe and only when fully covered by water.

DEVlaqua™ 9T is only intended for being used for cold drinking water with max. temperature 23 °C.

## DEVIsafe™ 20T - 230V



DEVIsafe™ is an extremely high-quality, 360° fully screened twin conductor cable with a tough outer sheath (UV stable). Its round profile and robust construction ensures a fast, simple and safe installation in multiple outdoor applications.

The cold lead is an installation cable with solid conductors ensuring fast installation with a clearly visible connection.

To ensure a long life-time, all cables are minutely inspected including tests for Ohmic resistance, high voltage and material controls to ensure the quality. This means that we are proud to supply our extended DEVIwarranty™.

### Benefits:

- Fast and easy to install
- Multiple application options
- Safe and robust
- Long life-time
- Maximum protection
- UV stable

### Standard compliance:

- IEC60800:2009

### Approvals:



Type	Value
Operation voltage	220 - 240 V~
Construction	Round, twin conductor with 360° screen, one cold lead
Output	20 W/m
Max. permissible use temperature, powered	60 °C
Max. permissible use temperature, unpowered	90 °C
Cable dimensions	Ø 6,9 mm
Deformation strength	>1500 N
Pulling strength	>500 N
Conductor insulation	PEX
Outer sheath	UV protected PVC
Screen	100% coverage; alu-foil; 0,5 mm <sup>2</sup> tinned copper drain wire
Cold lead	2,3 m, DTWC, screened
Min. installation temperature	-5 °C
Bending Ø, min.	50 mm
IP Class	IPX7

### Types

Item no.	Output @ 230V~	Cable length	Resistance	Cold lead	EAN no.
140F1273	125 W	6 m	430,1 Ohm	2 x 1,5 mm <sup>2</sup>	5703466224090
140F1274	250 W	12 m	216,5 Ohm	2 x 1,5 mm <sup>2</sup>	5703466224106
140F1275	335 W	17 m	157,3 Ohm	2 x 1,5 mm <sup>2</sup>	5703466224113
140F1276	505 W	25 m	105,2 Ohm	2 x 1,5 mm <sup>2</sup>	5703466224120
140F1277	675 W	33 m	79,2 Ohm	2 x 1,5 mm <sup>2</sup>	5703466224137
140F1278	830 W	42 m	63,4 Ohm	2 x 1,5 mm <sup>2</sup>	5703466224144
140F1279	1000 W	50 m	53,0 Ohm	2 x 1,5 mm <sup>2</sup>	5703466224151
140F1280	1200 W	60 m	44,1 Ohm	2 x 1,5 mm <sup>2</sup>	5703466224168
140F1281	1370 W	68 m	38,7 Ohm	2 x 1,5 mm <sup>2</sup>	5703466224175
140F1199 NEW 2018	1545 W	76 m	34,2 Ohm	2 x 1,5 mm <sup>2</sup>	5703466242940
140F1282	1700 W	85 m	31,2 Ohm	2 x 1,5 mm <sup>2</sup>	5703466224182
140F1283	2040 W	101 m	26,1 Ohm	2 x 2,5 mm <sup>2</sup>	5703466224199
140F1284	2360 W	118 m	22,4 Ohm	2 x 2,5 mm <sup>2</sup>	5703466224205
140F1285	2685 W	135 m	19,7 Ohm	2 x 2,5 mm <sup>2</sup>	5703466224212
140F1286	3025 W	152 m	17,5 Ohm	2 x 2,5 mm <sup>2</sup>	5703466224229
140F1287	3385 W	170 m	15,6 Ohm	2 x 2,5 mm <sup>2</sup>	5703466224236
140F1288	3895 W	194 m	13,6 Ohm	2 x 2,5 mm <sup>2</sup>	5703466224243



## DEVIsafe™ 20T - 400V



DEVIsafe™ is an extremely high-quality, 360° fully screened twin conductor cable with a tough outer sheath (UV stable). Its round profile and robust construction ensures a fast, simple and safe installation in multiple outdoor applications.

The cold lead is an installation cable with solid conductors ensuring fast installation with a clearly visible connection.

To ensure a long life-time, all cables are minutely inspected including tests for Ohmic resistance, high voltage and material controls to ensure the quality. This means that we are proud to supply our extended DEVIsafe™ warranty.

### Benefits:

- Fast and easy to install
- Multiple application options
- Safe and robust
- Long life-time
- Maximum protection
- UV stable

### Standard compliance:

- IEC60800:2009

### Approvals:



Type	Value
Operation voltage	400 V
Construction	Round, twin conductor with screen, one cold lead
Output	20 W/m
Max. permissible use temperature, powered	60 °C
Max. permissible use temperature, unpowered	90 °C
Cable dimensions	Ø 6,9 mm
Deformation strength	>1500 N
Pulling strength	>500 N
Conductor insulation	PEX
Outer sheath	UV protected PVC
Screen	100% coverage; alu-foil; 0,5 mm <sup>2</sup> tinned copper drain wire
Cold lead	2,3 m DTWC, screened
Min. installation temperature	-5 °C
Bending Ø, min.	6 x cable diameter (Ø)

### Types

Item no.	Output @ 400V~	Cable length	Resistance	Cold lead	EAN no.
140F1289	425 W	21 m	374,8 Ohm	2 x 1,5 mm <sup>2</sup>	5703466224250
140F1290	585 W	29 m	273,3 Ohm	2 x 1,5 mm <sup>2</sup>	5703466224267
140F1291	875 W	44 m	183,1 Ohm	2 x 1,5 mm <sup>2</sup>	5703466224274
140F1292	1165 W	58 m	137,7 Ohm	2 x 1,5 mm <sup>2</sup>	5703466224281
140F1293	1450 W	73 m	110,2 Ohm	2 x 1,5 mm <sup>2</sup>	5703466224298
140F1294	1740 W	87 m	92,1 Ohm	2 x 1,5 mm <sup>2</sup>	5703466224304
140F1295	2085 W	104 m	76,7 Ohm	2 x 2,5 mm <sup>2</sup>	5703466224311
140F1296	2665 W	133 m	60,1 Ohm	2 x 2,5 mm <sup>2</sup>	5703466224328
140F1297	2955 W	148 m	54,2 Ohm	2 x 2,5 mm <sup>2</sup>	5703466224335
140F1298	3530 W	176 m	45,3 Ohm	2 x 2,5 mm <sup>2</sup>	5703466224342
140F1299	4105 W	205 m	39,0 Ohm	2 x 2,5 mm <sup>2</sup>	5703466224359



## DEVIsnow™ 20T - 230V (DTCE-20)

DEVIsnow™ is an extremely high-quality, 360° fully screened twin conductor cable with a tough outer sheath (UV stable) and **cold lead 2,3 m long**. Its round profile and robust construction ensures a fast, simple and safe installation on roofs, in gutters, down drain pipes and on the ground.

The cold lead has solid conductors ensuring fast installation with a clearly visible connection.

To ensure a long life-time, all cables are minutely inspected including tests for Ohmic resistance, high voltage and material controls to ensure the quality. This means that we are proud to supply our extended DEVIwarranty™.

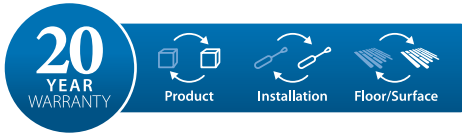

### Benefits:

- Fast and easy to install
- Multiple outdoor applications
- Safe and robust
- Long life-time
- Maximum protection
- UV stable

### Standard compliance:

- IEC60800:2009

### Approvals:



Type	Value
Operation voltage	220 - 240 V~
Construction	Twin conductor with 360° screening, one cold lead
Output	20 W/m
Max. permissible use temperature, powered	70 °C
Max. permissible use temperature, unpowered	90 °C
Cable diameter	7 mm
Deformation strength	>1500 N
Pulling strength	>300 N
Conductor insulation	FEP
Outer sheath	UV protected PVC
Screen	0,5 mm <sup>2</sup> Cu, 100% Alu-foil
Cold lead	2,3 m, DTWC
Min. installation temperature	-5 °C
Bending Ø, min.	50 mm
IP Class	IPX7

### Types

Item no.	Output @ 230V~	Resistance	Cable length	Cold lead	EAN no.
140F1116	125 W	423,2 Ω	6 m	2 x 1,5 mm <sup>2</sup>	5703466211908
83902100	250 W	211,6 Ω	12 m	2 x 1,5 mm <sup>2</sup>	5703466187456
140F1117	332 W	164,3 Ω	17 m	2 x 1,5 mm <sup>2</sup>	5703466211915
83902101	505 W	104,8 Ω	25 m	2 x 1,5 mm <sup>2</sup>	5703466187463
140F1118	677 W	78,1 Ω	33 m	2 x 1,5 mm <sup>2</sup>	5703466211922
83902102	855 W	61,9 Ω	40 m	2 x 1,5 mm <sup>2</sup>	5703466187470
83902103	1000 W	52,9 Ω	50 m	2 x 1,5 mm <sup>2</sup>	5703466187487
83902104	1200 W	44,1 Ω	60 m	2 x 1,5 mm <sup>2</sup>	5703466187494
83902105	1333 W	39,7 Ω	70 m	2 x 1,5 mm <sup>2</sup>	5703466187500
83902106	1695 W	31,2 Ω	85 m	2 x 1,5 mm <sup>2</sup>	5703466187517
83902107	2060 W	25,7 Ω	100 m	2 x 1,5 mm <sup>2</sup>	5703466187524
140F1119	2421 W	21,9 Ω	115 m	2 x 1,5 mm <sup>2</sup>	5703466211939
83902108	2685 W	19,7 Ω	135 m	2 x 1,5 mm <sup>2</sup>	5703466187531
83902109	3066 W	17,3 Ω	150 m	2 x 2,5 mm <sup>2</sup>	5703466187548
83902110	3382 W	15,6 Ω	170 m	2 x 2,5 mm <sup>2</sup>	5703466187555
83902111	3875 W	13,7 Ω	195 m	2 x 2,5 mm <sup>2</sup>	5703466187562



## DEVIsnow™ 20T - 400V (DTCE-20)

**DEVIsnow™** is an extremely high-quality, 360° fully screened twin conductor cable with a tough outer sheath (UV stable) and **cold lead 10 m long**. Its round profile and robust construction ensures a fast, simple and safe installation on roofs, in gutters, down drain pipes and on the ground.

The cold lead has solid conductors ensuring fast installation with a clearly visible connection.

To ensure a long life-time, all cables are minutely inspected including tests for Ohmic resistance, high voltage and material controls to ensure the quality. This means that we are proud to supply our extended DEVIwarranty™.

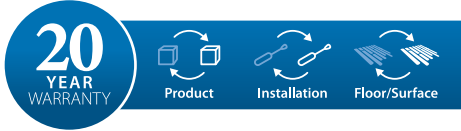

### Benefits:

- Fast and easy to install
- Multiple outdoor applications
- Safe and robust
- Long life-time
- Maximum protection
- UV stable

### Standard compliance:

- IEC60800:2009

### Approvals:



Type	Value
Operation voltage	400 V~
Construction	Twin conductor with 360° screening, one cold lead
Output	20 W/m
Max. permissible use temperature, powered	70 °C
Max. permissible use temperature, unpowered	90 °C
Cable diameter	7 mm
Deformation strength	>1500 N
Pulling strength	>300 N
Conductor insulation	FEP
Outer sheath	UV protected PVC
Screen	0,5 mm <sup>2</sup> Cu, 100% Alu-foil
Cold lead	10 m DTWC, 2 x 1,5 mm <sup>2</sup>
Min. installation temperature	-5 °C
Bending Ø, min.	50 mm
IP Class	IPX7

### Types

Item no.	Output @ 400V~	Resistance	Cable length	EAN no.
83902112	433 W	369,5 Ω	21 m	5703466187579
83902113	570 W	280,7 Ω	30 m	5703466187586
83902114	888 W	180,2 Ω	43 m	5703466187593
83902115	1165 W	137,3 Ω	58 m	5703466187609
83902116	1463 W	109,4 Ω	72 m	5703466187616
83902117	1780 W	89,9 Ω	85 m	5703466187623
83902118	2073 W	77,2 Ω	105 m	5703466187630
83902119	2628 W	60,9 Ω	135 m	5703466187647
83902120	2905 W	55,1 Ω	150 m	5703466187654
83902121	3245 W	49,3 Ω	170 m	5703466187661
83902122	4108 W	39,0 Ω	205 m	5703466187678

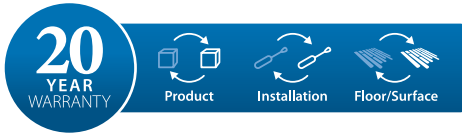

## DEVIsnow™ 30T - 230V (DTCE-30)

DEVIsnow™ is an extremely high-quality, 360° fully screened twin conductor cable with a tough black PVC outer sheath (UV stable) and **cold lead 2,3 and 30 m long**. Its round profile and robust construction ensures a fast, simple and safe installation on roofs, in gutters, down drain pipes and on the ground.

The cold lead has solid conductors ensuring fast installation with a clearly visible connection.

To ensure a long life-time, all cables are minutely inspected including tests for Ohmic resistance, high voltage and material controls to ensure the quality. This means that we are proud to supply our extended DEVIwarranty™.

### Benefits:

- Fast and easy to install
- Multiple outdoor applications
- Safe and robust
- Long life-time
- Maximum protection
- UV stable

### Standard compliance:

- IEC60800:2009

### Approvals:



Type	Value
Operation voltage	220 V - 240 V~
Construction	Twin conductor with 360° screening, one cold lead
Output	30 W/m
Max. permissible use temperature, powered	60 °C
Max. permissible use temperature, unpowered	90 °C
Cable diameter	7 mm
Deformation strength	>1500 N
Pulling strength	>300 N
Conductor insulation	FEP
Outer sheath	UV protected PVC
Screen	0,5 mm <sup>2</sup> Cu, 100% Alu-foil
Cold lead	Program 2,5 m and 30 m, DTWC
Min. installation temperature	-5 °C
Bending Ø, min.	50 mm
IP Class	IPX7

### Types DEVIsnow™ 30T - 230V with cold lead 2,3 m

Item no.	Output @ 230V~	Resistance	Cable length	Cold lead	EAN no.
89845995	150 W	352,7 Ω	5 m	2,3 m, 2x1,5 mm <sup>2</sup>	5703466187128
89846000	300 W	176,3 Ω	10 m	2,3 m, 2x1,5 mm <sup>2</sup>	5703466150115
89846002	400 W	132,3 Ω	14 m	2,3 m, 2x1,5 mm <sup>2</sup>	5703466150122
89846004	630 W	84,0 Ω	20 m	2,3 m, 2x1,5 mm <sup>2</sup>	5703466150139
89846006	830 W	63,7 Ω	27 m	2,3 m, 2x1,5 mm <sup>2</sup>	5703466150146
89846008	1020 W	51,9 Ω	34 m	2,3 m, 2x1,5 mm <sup>2</sup>	5703466150153
89846010	1250 W	42,3 Ω	40 m	2,3 m, 2x1,5 mm <sup>2</sup>	5703466150160
89846012	1350 W	39,2 Ω	45 m	2,3 m, 2x1,5 mm <sup>2</sup>	5703466150177
89846014	1440 W	36,7 Ω	50 m	2,3 m, 2x1,5 mm <sup>2</sup>	5703466150184
89846016	1700 W	31,1 Ω	55 m	2,3 m, 2x1,5 mm <sup>2</sup>	5703466150191
89846018	1860 W	28,4 Ω	63 m	2,3 m, 2x1,5 mm <sup>2</sup>	5703466150207
89846020	2060 W	25,7 Ω	70 m	2,3 m, 2x1,5 mm <sup>2</sup>	5703466150214
89846022	2340 W	22,3 Ω	78 m	2,3 m, 2x1,5 mm <sup>2</sup>	5703466150221
89846024	2420 W	21,9 Ω	85 m	2,3 m, 2x1,5 mm <sup>2</sup>	5703466150238
89846026	2930 W	18,1 Ω	95 m	2,3 m, 2x1,5 mm <sup>2</sup>	5703466150245
89846028	3290 W	16,1 Ω	110 m	2,3 m, 2x2,5 mm <sup>2</sup>	5703466150252
89846030	3680 W	14,4 Ω	125 m	2,3 m, 2x2,5 mm <sup>2</sup>	5703466150269
89846032	4110 W	12,9 Ω	140 m	2,3 m, 2x2,5 mm <sup>2</sup>	5703466150276

### Types DEVIsnow™ 30T - 230V with cold lead 30 m

Item no.	Output @ 230V~	Resistance	Cable length	Cold lead	EAN no.
140F0635	300 W	176,3 Ω	10 m	30 m, 2x1,5 mm <sup>2</sup>	5703466229392
140F0636	400 W	132,3 Ω	14 m	30 m, 2x1,5 mm <sup>2</sup>	5703466229408
140F0637	630 W	84,0 Ω	20 m	30 m, 2x1,5 mm <sup>2</sup>	5703466229415
140F0638	830 W	63,7 Ω	27 m	30 m, 2x1,5 mm <sup>2</sup>	5703466229422
140F0639	1020 W	51,9 Ω	34 m	30 m, 2x1,5 mm <sup>2</sup>	5703466229439
140F0640	1250 W	42,3 Ω	40 m	30 m, 2x1,5 mm <sup>2</sup>	5703466229446
140F0641	1350 W	39,2 Ω	45 m	30 m, 2x1,5 mm <sup>2</sup>	5703466229453
140F0642	1440 W	36,7 Ω	50 m	30 m, 2x1,5 mm <sup>2</sup>	5703466229460
140F0643	1700 W	31,1 Ω	55 m	30 m, 2x1,5 mm <sup>2</sup>	5703466229477
140F0644	1860 W	28,4 Ω	63 m	30 m, 2x1,5 mm <sup>2</sup>	5703466229484
140F0645	2060 W	25,7 Ω	70 m	30 m, 2x1,5 mm <sup>2</sup>	5703466229491
140F0646	2340 W	22,3 Ω	78 m	30 m, 2x1,5 mm <sup>2</sup>	5703466229507
140F0647	2420 W	21,9 Ω	85 m	30 m, 2x1,5 mm <sup>2</sup>	5703466229514
140F0648	2930 W	18,1 Ω	95 m	30 m, 2x1,5 mm <sup>2</sup>	5703466229521
140F0649	3290 W	16,1 Ω	110 m	30 m, 2x2,5 mm <sup>2</sup>	5703466229538
140F0650	3680 W	14,4 Ω	125 m	30 m, 2x2,5 mm <sup>2</sup>	5703466229545
140F0651	4110 W	12,9 Ω	140 m	30 m, 2x2,5 mm <sup>2</sup>	5703466229552



## DEVIsnow™ 30T - 400V (DTCE-30)

DEVIsnow™ is an extremely high-quality, 360° fully screened twin conductor cable with a tough black PVC outer sheath (UV stable) and **cold lead 10 and 30 m long**. Its round profile and robust construction ensures a fast, simple and safe installation on roofs, in gutters, down drain pipes and on the ground.

The cold lead has solid conductors ensuring fast installation with a clearly visible connection.

To ensure a long life-time, all cables are minutely inspected including tests for Ohmic resistance, high voltage and material controls to ensure the quality. This means that we are proud to supply our extended DEVIwarranty™.

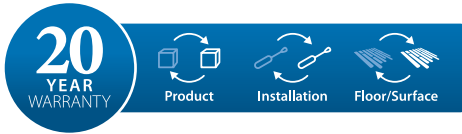

### Benefits:

- Fast and easy to install
- Multiple outdoor applications
- Safe and robust
- Long life-time
- Maximum protection
- UV stable

### Standard compliance:

- IEC60800:2009

### Approvals:



Type	Value
Operation voltage	400 V~
Construction	Twin conductor with 360° screening, one cold lead
Output	30 W/m
Max. permissible use temperature, powered	60 °C
Max. permissible use temperature, unpowered	90 °C
Cable diameter	7 mm
Deformation strength	>1500 N
Pulling strength	>300 N
Conductor insulation	FEP
Outer sheath	UV protected PVC
Screen	0,5 mm <sup>2</sup> Cu, 100% Alu-foil
Cold lead	Program 10 m and 30 m, DTWC
Min. installation temperature	-5 °C
Bending Ø, min.	50 mm
IP Class	IPX7

### Types DEVIsnow™ 30T - 400V with cold lead 10 m

Item no.	Output @ 230V~	Resistance	Cable length	Cold lead	EAN no.
89845996	267 W	599,3 Ω	8,5 m	10 m, 2x1,5 mm <sup>2</sup>	5703466187241
89846050	520 W	307,7 Ω	17,5 m	10 m, 2x1,5 mm <sup>2</sup>	5703466163092
89846053	1090 W	146,8 Ω	35,0 m	10 m, 2x1,5 mm <sup>2</sup>	5703466163108
89846056	2160 W	74,1 Ω	70,0 m	10 m, 2x1,5 mm <sup>2</sup>	5703466163115
89846060	3225 W	49,6 Ω	110,0 m	10 m, 2x1,5 mm <sup>2</sup>	5703466163122
89846062	4295 W	37,3 Ω	145,0 m	10 m, 2x1,5 mm <sup>2</sup>	5703466164648
89846063	4955 W	32,3 Ω	170,0 m	10 m, 2x2,5 mm <sup>2</sup>	5703466164655
89846065	5770 W	27,7 Ω	190,0 m	10 m, 2x2,5 mm <sup>2</sup>	5703466163139
89846067	6470 W	24,7 Ω	215,0 m	10 m, 2x2,5 mm <sup>2</sup>	5703466164662

### Types DEVIsnow™ 30T - 400V with cold lead 30 m

Item no.	Output @ 230V~	Resistance	Cable length	Cold lead	EAN no.
140F0652	520 W	307,7 Ω	17,5 m	30 m, 2x1,5 mm <sup>2</sup>	5703466163092
140F0653	1090 W	146,8 Ω	35,0 m	30 m, 2x1,5 mm <sup>2</sup>	5703466163108
140F0654	2160 W	74,1 Ω	70,0 m	30 m, 2x1,5 mm <sup>2</sup>	5703466163115
140F0655	3225 W	49,6 Ω	110,0 m	30 m, 2x1,5 mm <sup>2</sup>	5703466163122
140F0656	4295 W	37,3 Ω	145,0 m	30 m, 2x1,5 mm <sup>2</sup>	5703466164648
140F0657	4955 W	32,3 Ω	170,0 m	30 m, 2x2,5 mm <sup>2</sup>	5703466164655
140F0658	5770 W	27,7 Ω	190,0 m	30 m, 2x2,5 mm <sup>2</sup>	5703466163139
140F0659	6470 W	24,7 Ω	215,0 m	30 m, 2x2,5 mm <sup>2</sup>	5703466164662





## DEVIsnow™ 300T - 230V (DTCE-300)

DEVIsnow™ is an extremely high-quality, 360° fully screened twin conductor heating mat with a tough outer sheath (UV stable). Its round profile and robust construction ensures a fast, simple and safe installation on the ground.

The cold lead has solid conductors ensuring fast installation with a clearly visible connection.

To ensure a long life-time, all cables are minutely inspected including tests for Ohmic resistance, high voltage and material controls to ensure the quality. This means that we are proud to supply our extended DEVIwarranty™.

**Note.** DEVIsnow™ heating mat is not approved for installation on roof because the fixing tape is not UV-stable.

**20**  
YEAR  
WARRANTY

Product    Installation    Floor/Surface

### Benefits:

- Fast and easy to install
- Multiple outdoor applications
- Safe and robust
- Long life-time
- Maximum protection
- UV stable

### Standard compliance:

- IEC60800:2009

### Approvals:



Type	Value
Operation voltage	230 V
Construction	Round, twin conductor with 360° screening, one cold lead
Output	300 W/m <sup>2</sup>
Max. permissible use temperature, powered	60 °C
Max. permissible use temperature, unpowered	90 °C
Cable thickness	7 mm
Deformation strength	>1500 N
Pulling strength	>300 N
Conductor insulation	FEP
Outer sheath	PVC
Screen	100% coverage; alu-foil; 0,5 mm <sup>2</sup> tinned copper drain wire
Cold lead	10 m DTWC, earthed
Min. installation temperature	-5 °C
Bending Ø	50 mm
IP Class	IPX7

### Types

Item no.	Output @ 230V~	Dimensions (W x L)	Area	Resistance	Cold lead	EAN no.
83902030	288 W	0,5 x 2,0 m	1,0 m <sup>2</sup>	184 Ω	2 x 1,5 mm <sup>2</sup>	5703466187258
83902031	613 W	0,5 x 4,0 m	2,0 m <sup>2</sup>	86 Ω	2 x 1,5 mm <sup>2</sup>	5703466187265
83902032	1225 W	0,5 x 8,0 m	4,0 m <sup>2</sup>	43 Ω	2 x 1,5 mm <sup>2</sup>	5703466187272
83902033	1440 W	0,5 x 9,8 m	5,9 m <sup>2</sup>	38 Ω	2 x 1,5 mm <sup>2</sup>	5703466187289
83902034	1887 W	0,5 x 12,2 m	6,1 m <sup>2</sup>	28 Ω	2 x 1,5 mm <sup>2</sup>	5703466187296
83902035	2022 W	0,5 x 14,0 m	7,0 m <sup>2</sup>	26 Ω	2 x 1,5 mm <sup>2</sup>	5703466187302
83902036	2528 W	0,5 x 16,0 m	8,0 m <sup>2</sup>	21 Ω	2 x 1,5 mm <sup>2</sup>	5703466187319
83902037	3240 W	0,5 x 22,0 m	11,0 m <sup>2</sup>	16 Ω	2 x 2,5 mm <sup>2</sup>	5703466187326
83902038	3770 W	0,5 x 24,0 m	12,0 m <sup>2</sup>	14 Ω	2 x 2,5 mm <sup>2</sup>	5703466187333
83902039	410 W	0,75 x 1,8 m	1,4 m <sup>2</sup>	129 Ω	2 x 1,5 mm <sup>2</sup>	5703466187340
83902040	637 W	0,75 x 2,6 m	2,0 m <sup>2</sup>	83 Ω	2 x 1,5 mm <sup>2</sup>	5703466187357
83902041	1227 W	0,75 x 5,4 m	4,1 m <sup>2</sup>	43 Ω	2 x 1,5 mm <sup>2</sup>	5703466187364
83902042	1445 W	0,75 x 6,6 m	5,0 m <sup>2</sup>	36 Ω	2 x 1,5 mm <sup>2</sup>	5703466187371
83902043	2080 W	0,75 x 9,2 m	6,9 m <sup>2</sup>	25 Ω	2 x 1,5 mm <sup>2</sup>	5703466187388
83902044	2285 W	0,75 x 10,6 m	8,0 m <sup>2</sup>	23 Ω	2 x 1,5 mm <sup>2</sup>	5703466187395
83902045	3300 W	0,75 x 14,6 m	10,1 m <sup>2</sup>	16 Ω	2 x 2,5 mm <sup>2</sup>	5703466187401
83902046	3824 W	0,75 x 16,0 m	12,0 m <sup>2</sup>	14 Ω	2 x 2,5 mm <sup>2</sup>	5703466187418
83902047	750 W	1,00 x 3,0 m	3,0 m <sup>2</sup>	71 Ω	2 x 1,5 mm <sup>2</sup>	5703466187425
83902048	1907 W	1,00 x 6,2 m	6,2 m <sup>2</sup>	28 Ω	2 x 1,5 mm <sup>2</sup>	5703466187432
83902049	3874 W	1,00 x 12,0 m	12,0 m <sup>2</sup>	14 Ω	2 x 2,5 mm <sup>2</sup>	5703466187449



## DEVIsnow™ 300T - 400V (DTCE-300)

DEVIsnow™ is an extremely high-quality, 360° fully screened twin conductor heating mat with a tough outer sheath (UV stable). Its round profile and robust construction ensures a fast, simple and safe installation on the ground.

The cold lead has solid conductors ensuring fast installation with a clearly visible connection.

To ensure a long life-time, all cables are minutely inspected including tests for Ohmic resistance, high voltage and material controls to ensure the quality. This means that we are proud to supply our extended DEVIwarranty™.

**Note.** DEVIsnow™ heating mat is not approved for installation on roof because the fixing tape is not UV-stable.

20

YEAR  
WARRANTY



Product



Installation



Floor/Surface

### Benefits:

- Fast and easy to install
- Multiple outdoor applications
- Safe and robust
- Long life-time
- Maximum protection
- UV stable

### Standard compliance:

- IEC60800:2009

### Approvals:



Type	Value
Operation voltage	400 V
Construction	Round, twin conductor with 360° screening, one cold lead
Output	300 W/m <sup>2</sup>
Max. permissible use temperature, powered	60 °C
Max. permissible use temperature, unpowered	90 °C
Cable thickness	7 mm
Deformation strength	>1500 N
Pulling strength	>300 N
Conductor insulation	FEP
Outer sheath	PVC
Screen	100% coverage; alu-foil; 0,5 mm <sup>2</sup> tinned copper drain wire
Cold lead	10 m DTWC, earthed
Min. installation temperature	-5 °C
Bending Ø	50 mm
IP Class	IPX7

### Types

Item no.	Output @ 400 V~	Dimensions (W x L)	Area	Resistance	Cold lead	EAN no.
83902020	520 W	0,5 x 3,4 m	1,70 m <sup>2</sup>	308 Ω	2 x 1,5 mm <sup>2</sup>	5703466157657
83902023	1050 W	0,5 x 7,0 m	3,50 m <sup>2</sup>	152 Ω	2 x 1,5 mm <sup>2</sup>	5703466157664
83902026	1760 W	0,5 x 11,8 m	5,90 m <sup>2</sup>	91 Ω	2 x 1,5 mm <sup>2</sup>	5703466157671
83902029	2285 W	0,5 x 15,8 m	7,90 m <sup>2</sup>	70 Ω	2 x 1,5 mm <sup>2</sup>	5703466157688
83902050	700 W	0,75 x 3,2 m	2,40 m <sup>2</sup>	229 Ω	2 x 1,5 mm <sup>2</sup>	5703466157695
83902053	1050 W	0,75 x 4,8 m	3,60 m <sup>2</sup>	152 Ω	2 x 1,5 mm <sup>2</sup>	5703466157701
83902056	1750 W	0,75 x 8,0 m	6,00 m <sup>2</sup>	91 Ω	2 x 1,5 mm <sup>2</sup>	5703466157718
83902059	2630 W	0,75 x 11,0 m	8,25 m <sup>2</sup>	61 Ω	2 x 1,5 mm <sup>2</sup>	5703466157725
83902062	2890 W	0,75 x 13,0 m	9,75 m <sup>2</sup>	55 Ω	2 x 1,5 mm <sup>2</sup>	5703466157732
83902065	3625 W	0,75 x 16,0 m	12,00 m <sup>2</sup>	44 Ω	2 x 1,5 mm <sup>2</sup>	5703466157749
83902068	4270 W	0,75 x 19,4 m	14,55 m <sup>2</sup>	37 Ω	2 x 1,5 mm <sup>2</sup>	5703466157756
83902071	5750 W	0,75 x 25,4 m	19,05 m <sup>2</sup>	28 Ω	2 x 2,5 mm <sup>2</sup>	5703466157763
83902073	6300 W	0,75 x 28,2 m	21,15 m <sup>2</sup>	25 Ω	2 x 2,5 mm <sup>2</sup>	5703466161432
83902080	1750 W	1,00 x 6,0 m	6,0 m <sup>2</sup>	90 Ω	2 x 1,5 mm <sup>2</sup>	5703466157770
83902083	3675 W	1,00 x 12,0 m	12,0 m <sup>2</sup>	44 Ω	2 x 1,5 mm <sup>2</sup>	5703466157787
83902086	4250 W	1,00 x 14,8 m	14,8 m <sup>2</sup>	38 Ω	2 x 1,5 mm <sup>2</sup>	5703466157794
83902089	5840 W	1,00 x 19,0 m	19,0 m <sup>2</sup>	27 Ω	2 x 2,5 mm <sup>2</sup>	5703466157800



## DEVIsnow™ Drum Goods (DTCE) NEW





DEVIsnow™ heating cable on drum is an extremely high-quality, 360° fully screened twin conductor cable with a tough black PVC outer sheath (UV stable). Its round profile and robust construction ensures a fast, simple and safe installation on roofs, in gutters, down drain pipes and on the ground.

To ensure a long life-time, all cables are minutely inspected including tests for Ohmic resistance, high voltage and material controls to ensure the quality. This means that we are proud to supply our extended DEVIwarranty™.

DEVIsnow™ can be customized for the specific project, depending on voltage, required output, length of heating cable and length of cold leads.



**Note:** It is the full responsibility of the installer/designer to use proper cold lead dimensioned for the purpose and assembly sets that establish sufficient mechanical strength, flammability resistance and water tightness - and to design the heating unit with correct output for the specific application to avoid overheating of the cable or building materials.

Benefits:	Type	Value
<ul style="list-style-type: none"> <li>Fast and easy to install</li> <li>Multiple outdoor applications</li> <li>Safe and robust</li> <li>Long life-time</li> <li>Maximum protection</li> <li>UV stable</li> </ul>	Operation voltage, max	U <sub>o</sub> /U = 300/500 V~
	Construction	Twin conductor with 360° screening
	Output, max	30 W/m
	Max. permissible use temperature, powered	60 °C
	Max. permissible use temperature, unpowered	90 °C
	Cable diameter	7 mm
<b>Standard compliance:</b> <ul style="list-style-type: none"> <li>IEC60800:2009</li> </ul> <b>Approvals:</b> <div style="display: flex; justify-content: space-around; align-items: center;">     </div>	Deformation strength	>1500 N
	Pulling strength	>300 N
	Conductor insulation	FEP
	Outer sheath	UV protected PVC
	Screen	0,5 mm <sup>2</sup> Cu, 100% Alu-foil
	Min. installation temperature	-5 °C
	Bending Ø, min.	50 mm
	IP Class	IPX7

### Types

Item no.	Resistance	EAN no.
84805400	9,36 Ω/m	5703466146248
84805403	4,19 Ω/m	5703466146255
84805406	2,368 Ω/m	5703466146262
84805409	1,519 Ω/m	5703466146279
84805412	1,057 Ω/m	5703466146286
84805415	0,735 Ω/m	5703466146293
84805418	0,567 Ω/m	5703466146309
84805421	0,451 Ω/m	5703466146316
84805424	0,367 Ω/m	5703466146323
84805427	0,257 Ω/m	5703466146330
84805430	0,19 Ω/m	5703466146347
84805433	0,146 Ω/m	5703466146354
84805436	0,115 Ω/m	5703466146361
84805439	0,092 Ω/m	5703466146378
84805442	0,07 Ω/m	5703466146385
84805445	0,055 Ω/m	5703466146392

### Accessories

Item no.	Name	Description	EAN no.
18055249	<b>DEVICrimp™ for DEVIsnow (DTCE)</b>	Connection kit for DEVIsnow™ (DTCE)	5703466199251
18055350	<b>DEVICrimp™ ass/repair kit 2-cond. Cs2a/cs2b</b>	Connection kit for twin-conductor heating cable	5703466003381



## DEVIasphalt™ 30T (DTIK-30)

DEVIasphalt™ is an extremely high-quality, 360° fully screened twin conductor cable with a very robust outer sheath (UV stable), designed especially for embedding in mastic or asphalt concrete (road asphalt).

The cold lead has solid conductors ensuring fast installation with a clearly visible connection.

To ensure a long life-time, all cables are minutely inspected including tests for Ohmic resistance, high voltage and material controls to ensure the quality. This means that we are proud to supply our extended DEVIwarranty™.

### Benefits:

- Fast and easy to install
- Asphalt applications
- Very robust
- Long life-time
- Maximum protection
- UV stable
- PVC free

### Standard compliance:

- IEC60800:2009
- EN62395-1:2006

### Approvals:



Type	Value
Operation voltage	400 V~
Construction	Twin conductor with 360° screening, one cold lead
Output	30 W/m
Max. permissible use temperature, powered	60 °C
Max. permissible use temperature, unpowered	85 °C
Max. short term temperature	240 °C
Cable thickness	7 mm
Deformation strength	>1500 N
Pulling strength	>300 N
Conductor insulation	FEP
Outer sheath	XLPO
Screen	1 mm <sup>2</sup> tinned Cu + aluminium foil
Cold lead	10 m DTWK 2 x 2,5 mm <sup>2</sup>
Min. installation temperature	-5 °C
Bending Ø, min.	50 mm
IP Class	IPX7

### Types

Item no.	Output @ 400V~	Resistance	Length	EAN no.
83900200	267 W	599,3 Ω	8,5 m	5703466192856
83900201	520 W	307,7 Ω	17,5 m	5703466192863
83900202	1090 W	146,8 Ω	35,0 m	5703466192870
83900203	2160 W	74,1 Ω	70,0 m	5703466192887
83900204	3225 W	49,1 Ω	110,0 m	5703466192894
83900205	4295 W	37,3 Ω	145,0 m	5703466192900
83900206	4955 W	32,3 Ω	170,0 m	5703466192917
83900207	5770 W	27,7 Ω	190,0 m	5703466192924
83900208	6470 W	24,7 Ω	215,0 m	5703466192931



## DEVIasphalt™ 300T - 230 V (DTIK-300)

DEVIasphalt™ is an extremely high-quality, 360° fully screened twin conductor heating mat with a very robust outer sheath (UV stable), designed especially for embedding in mastic or asphalt concrete (road asphalt).

The cold lead has solid conductors ensuring fast installation with a clearly visible connection.

To ensure a long life-time, all cables are minutely inspected including tests for Ohmic resistance, high voltage and material controls to ensure the quality. This means that we are proud to supply our extended DEVIwarranty™.

### Benefits:

- Fast and easy to install
- Asphalt applications
- Very robust
- Long life-time
- Maximum protection
- UV stable
- PVC free

### Standard compliance:

- IEC60800:2009
- EN62395-1:2006

### Approvals:



Type	Value
Operation voltage	230V~
Construction	Twin conductor with 360° screening, one cold lead
Output	300 W/m <sup>2</sup>
Max. permissible use temperature, powered	60°C
Max. permissible use temperature, unpowered	85°C
Max. short term installation temperature	240°C
Cable thickness	7 mm
Deformation strength	>1500 N
Pulling strength	> 300 N
Conductor insulation	FEP
Outer sheath	XLPO
Screen	1 mm <sup>2</sup> tinned Cu + aluminium foil
Cold lead	10 m DTWK 2 x 2,5 mm <sup>2</sup>
Min. installation temperature	-5°C
Bending Ø, min.	50 mm
IP Class	IPX7

### Types

Item no.	Output @ 230V~	Heated area	Resistance	Dimensions (W x L)	EAN no.
140F0660	292 W	1.0 m <sup>2</sup>	181.0 Ω	0.5 x 2.0 m	5703466233184
140F0661	530 W	2.0 m <sup>2</sup>	85.1 Ω	0.5 x 4.0 m	5703466233191
140F0662	1208 W	4.1 m <sup>2</sup>	43.8 Ω	0.5 x 8.2 m	5703466233207
140F0663	1460 W	4.9 m <sup>2</sup>	36.2 Ω	0.5 x 9.8 m	5703466233214
140F0664	1883 W	6.2 m <sup>2</sup>	28.1 Ω	0.5 x 12.4 m	5703466233221
140F0665	2080 W	6.9 m <sup>2</sup>	25.4 Ω	0.5 x 13.8 m	5703466233238
140F0666	2471 W	8.3 m <sup>2</sup>	21.4 Ω	0.5 x 16.6 m	5703466233245
140F0667	3285 W	11.0 m <sup>2</sup>	16.1 Ω	0.5 x 22.0 m	5703466233252
140F0668	3700 W	12.4 m <sup>2</sup>	14.3 Ω	0.5 x 24.8 m	5703466233269



## DEVIasphalt™ 300T - 400 V (DTIK-300)

**DEVIasphalt™** is an extremely high-quality, 360° fully screened twin conductor heating mat with a very robust outer sheath (UV stable) and **cold lead 10 m and 30 long**, designed especially for embedding in mastic or asphalt concrete (road asphalt).

The cold lead has solid conductors ensuring fast installation with a clearly visible connection.

To ensure a long life-time, all cables are minutely inspected including tests for Ohmic resistance, high voltage and material controls to ensure the quality. This means that we are proud to supply our extended DEVIwarranty™.

### Benefits:

- Fast and easy to install
- Asphalt applications
- Very robust
- Long life-time
- Maximum protection
- UV stable
- PVC free

### Standard compliance:

- IEC60800:2009
- EN62395-1:2006

### Approvals:



Type	Value
Operation voltage	400 V~
Construction	Twin conductor with 360° screening, one cold lead
Output	300 W/m <sup>2</sup>
Max. ambient temperature	85 °C
Max. short term temperature	240 °C
Cable thickness	7 mm
Deformation strength	> 1500 N
Pulling strength	> 300 N
Conductor insulation	FEP
Outer sheath	XLPO
Screen	1 mm <sup>2</sup> tinned Cu + aluminium foil
Cold lead	10 m and 30 m, DTWK 2 x 2,5 mm <sup>2</sup>
Min. installation temperature	-5 °C
Bending Ø, min.	50 mm
IP Class	IPX7

### Types DEVIasphalt™ 300T with 10 m cold lead

Item no.	Output @ 400V~	Heated area	Resistance	Dimensions (W x L)	EAN no.
83900162	520 W	1,70 m <sup>2</sup>	307,7 Ω	0,5 x 3,4 m	5703466192689
83900163	1050 W	3,50 m <sup>2</sup>	152,3 Ω	0,5 x 7,0 m	5703466192696
83900164	1760 W	5,90 m <sup>2</sup>	90,9 Ω	0,5 x 11,8 m	5703466192702
83900165	2285 W	7,90 m <sup>2</sup>	70,0 Ω	0,5 x 15,8 m	5703466192719
83900166	700 W	2,40 m <sup>2</sup>	228,6 Ω	0,75 x 3,2 m	5703466192726
83900167	1050 W	3,60 m <sup>2</sup>	152,3 Ω	0,75 x 4,8 m	5703466192733
83900168	1750 W	6,00 m <sup>2</sup>	90,9 Ω	0,75 x 8,0 m	5703466192740
83900169	2630 W	8,25 m <sup>2</sup>	60,8 Ω	0,75 x 11,0 m	5703466192757
83900170	2890 W	9,75 m <sup>2</sup>	55,4 Ω	0,75 x 13,0 m	5703466192764
83900171	3625 W	12,00 m <sup>2</sup>	44,1 Ω	0,75 x 16,0 m	5703466192771
83900172	4270 W	14,55 m <sup>2</sup>	37,5 Ω	0,75 x 19,4 m	5703466192788
83900173	5750 W	19,05 m <sup>2</sup>	27,8 Ω	0,75 x 25,4 m	5703466192795
83900174	6570 W	21,15 m <sup>2</sup>	24,4 Ω	0,75 x 28,2 m	5703466192801
83900175	1770 W	6,00 m <sup>2</sup>	90,4 Ω	1,00 x 6,0 m	5703466192818
83900176	3675 W	12,00 m <sup>2</sup>	43,5 Ω	1,00 x 12,0 m	5703466192825
83900177	4250 W	14,80 m <sup>2</sup>	37,6 Ω	1,00 x 14,8 m	5703466192832
83900178	5840 W	19,00 m <sup>2</sup>	27,4 Ω	1,00 x 19,0 m	5703466192849



## Types DEVLasphalt™ 300T with 30 m cold lead

Item no.	Output @ 400V~	Heated area	Resistance	Dimensions (W x L)	EAN no.
140F0601	520 W	1,70 m <sup>2</sup>	307,7 Ω	0,5 x 3,4 m	5703466229057
140F0602	1050 W	3,50 m <sup>2</sup>	152,3 Ω	0,5 x 7,0 m	5703466229064
140F0603	1760 W	5,90 m <sup>2</sup>	90,9 Ω	0,5 x 11,8 m	5703466229071
140F0604	2285 W	7,90 m <sup>2</sup>	70,0 Ω	0,5 x 15,8 m	5703466229088
140F0605	700 W	2,40 m <sup>2</sup>	228,6 Ω	0,75 x 3,2 m	5703466229095
140F0606	1050 W	3,60 m <sup>2</sup>	152,3 Ω	0,75 x 4,8 m	5703466229101
140F0607	1750 W	6,00 m <sup>2</sup>	90,9 Ω	0,75 x 8,0 m	5703466229118
140F0608	2630 W	8,25 m <sup>2</sup>	60,8 Ω	0,75 x 11,0 m	5703466229125
140F0609	2890 W	9,75 m <sup>2</sup>	55,4 Ω	0,75 x 13,0 m	5703466229132
140F0610	3625 W	12,00 m <sup>2</sup>	44,1 Ω	0,75 x 16,0 m	5703466229149
140F0611	4270 W	14,55 m <sup>2</sup>	37,5 Ω	0,75 x 19,4 m	5703466229156
140F0612	5750 W	19,05 m <sup>2</sup>	27,8 Ω	0,75 x 25,4 m	5703466229163
140F0613	6570 W	21,15 m <sup>2</sup>	24,4 Ω	0,75 x 28,2 m	5703466229170
140F0614	1770 W	6,00 m <sup>2</sup>	90,4 Ω	1,00 x 6,0 m	5703466229187
140F0615	3675 W	12,00 m <sup>2</sup>	43,5 Ω	1,00 x 12,0 m	5703466229194
140F0616	4250 W	14,80 m <sup>2</sup>	37,6 Ω	1,00 x 14,8 m	5703466229200
140F0617	5840 W	19,00 m <sup>2</sup>	27,4 Ω	1,00 x 19,0 m	5703466229217

## Accessories

Item no.	Type	EAN no.
18055355	DEVlcrimp repair kit 2-cond. DEVLasphalt	5703466195192



## DEVipeguard™ 10 (B), DEVipeguard™ 25 (B), DEVipeguard™ 33 (B)

The DEVipeguard™ is a self-limiting heating cable that is mainly used for frost protection of pipes. The self-limiting capability of the cable ensures that the output of the cable increase or decrease according to ambient temperature. The cable will maintain its functionality even when shortened.

The polyolefin outer sheath is highly resistant to harsh environmental conditions and corrosion and it also serves as a protection against mechanical influences.

The cables are not approved for use in drinking water.

Benefits:	Type	Value
<ul style="list-style-type: none"> <li>Cut to length on site</li> <li>PVC free</li> </ul>	Operation voltage	230 V AC
<b>Standard compliance:</b> <ul style="list-style-type: none"> <li>DIN VDE 0254: 1994-06</li> </ul>	Output (min-max): DEVipeguard™ 10 DEVipeguard™ 25 DEVipeguard™ 33	10 W/m @ 10 °C (10-15 W/m @ 10 °C) 25 W/m @ 10 °C (25-32,5 W/m @ 10 °C) 33 W/m @ 10 °C (30-39 W/m @ 10 °C)
	Maximum permissible use temperature	65 °C, powered 85 °C, unpowered
	Minimum installation temperature	-50 °C
<b>Approvals:</b> 	Cable dimensions	11,8 mm x 5,5 mm
	Outer sheath: DEVipeguard™ 10 DEVipeguard™ 25 DEVipeguard™ 33	Blue, TPE Red, TPE Brown, TPE
	Screen	Tinned copper braid
	Minimum braid coverage	70%
	Maximum resistance protective braid	18,2 Ω/Km
	Bending Ø, min.	50 mm (Ø to the inside of the cable)

### Types DEVipeguard™ 10

Item no.	Type	Length	Min-max length per drum	Number of length allowed on drum, max	EAN no.
98300708	DEVipeguard™ 10	Drum, 100 m	100 m	1	5703466177174
98300700	DEVipeguard™ 10	Drum, 270 m	270-330 m	1	5703435005552
98300707	DEVipeguard™ 10	Drum, 720 m	720-880 m	2, between 100 & 880 m	5703466096598
98300709	DEVipeguard™ 10	Cut-to-length	1 m	-	5703466193358

### Types DEVipeguard™ 25

Item no.	Type	Length	Min-max length per drum	Number of length allowed on drum, max	EAN no.
98300761	DEVipeguard™ 25	Drum, 100 m	100 m	1	5703466177181
98300759	DEVipeguard™ 25	Drum, 270 m	270-330 m	1	5703435005569
98300758	DEVipeguard™ 25	Drum, 720 m	720-880 m	2, between 100 & 880 m	5703466096604
98300763	DEVipeguard™ 25	Cut-to-length	1 m	-	5703466193365

### Types DEVipeguard™ 33

Item no.	Type	Length	Min-max length per drum	Number of length allowed on drum, max	EAN no.
98300764	DEVipeguard™ 33	305 m, drum	305 m	1	5703466196120
98300672	DEVipeguard™ 33	Cut-to-length	1 m	-	5703466193341

RCD of 30 mA is required, max. 500 m of self-limiting heating cable per RCD.

**Maximum heating circuit length on a pipe, with circuit breaker with C-characteristic**

Switch on temperature	DEVipeguard™ 10				DEVipeguard™ 25				DEVipeguard™ 33			
	16 A	20 A	25 A	32 A	16 A	20 A	25 A	32 A	16 A	20 A	25 A	32 A
10 °C	205 m	205 m	205 m	205 m	88 m	117 m	120 m	126 m	70 m	90 m	98 m	108 m
-15 °C	139 m	186 m	190 m	195 m	58 m	75 m	95 m	117 m	49 m	64 m	80 m	95 m
-30 °C	120 m	150 m	170 m	195 m	45 m	64 m	82 m	100 m	43 m	52 m	65 m	82 m

**Heating power**

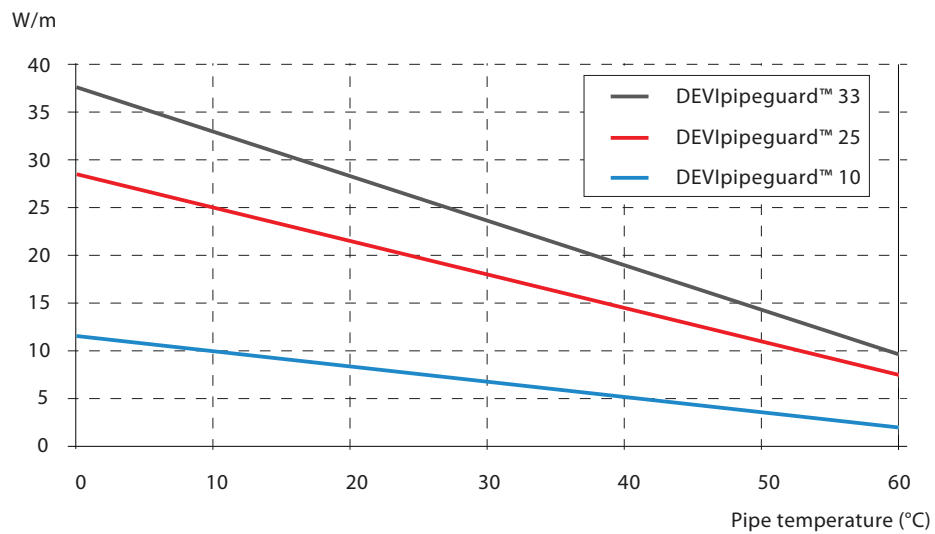

Output of heating cable installed and measured on a pipe.

## DEVIconnecto

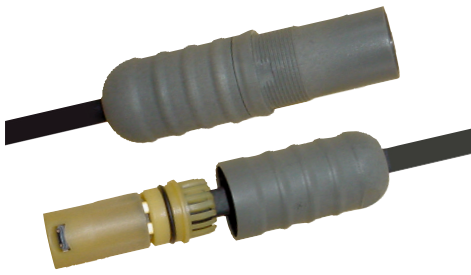

The DEVIconnecto programme gives you different solutions for easy and safe connection of DEVI self-limiting heating cables - DEVIceguard™ (B), DEVIpipeguard™ (B), DEVIhotwatt™ (B).

Using DEVIconnecto to wire up a heating circuit is fast, requiring only a knife and a diagonal cutter.

### Benefits:

- Cost savings by reduced assembly time
- Great reliability of assembly simplicity
- Safe electrical contacting by precise clamp cutting technology

### Approvals:

- VDE/CE

Type	Value
Operation voltage, max.	250 V~
Max. current	16 A
Ambient temperature	-25 °C to +60 °C
On request	-25 °C to +85 °C
IP class	IP 66

### Types

Item no.	Product name	Description	EAN no.
19808360	DEVIconnecto B-A	Connection power supply	5703466103067
19808361	DEVIconnecto B-C	Heating cable connection	5703466103074
19808362	DEVIconnecto B-E	End termination	5703466103081
19808363	DEVIconnecto B-S	Connection and end termination	5703466103098
19808364	DEVIconnecto B-T	Y-junction + end termination	5703466103104
19808365	DEVIconnecto B-TE2	Y-junction + 2 end terminations	5703466103111
19808366	DEVIconnecto B-TE3	Y-junction + 3 end terminations	5703466103128
19808367	DEVIconnecto B-X	X-junction + 2 end terminations	5703466103135
19808390	DEVIconnecto Bracket	Bracket and 6 cable ties	5703466125021

**ATTENTION.** DEVIconnecto may not be put in the gutters when used with DEVIceguard. It must be installed in a dry place.

### Selection chart. DEVIconnecto for heating cables with braiding

Illustration	Name	Description
	DEVIconnecto B-S	Heating cable connection with 1,5 m power cable and end terminal
	DEVIconnecto B-C	Heating cable slice/extension for connecting two heating cables
	DEVIconnecto B-T	Heating cable T-branch as a T-junction for three heating cables and 1 end terminal
	DEVIconnecto B-TE2	Heating cable double connection with 1,5 m power cable and 2 end terminals
	DEVIconnecto B-TE3	Heating cable T-branch with 1,5 m power cable and 3 end terminals
	DEVIconnecto B-X	Heating cable X-branch for 4 heating cables incl. 2 end terminals
	DEVIconnecto B-A	Heating cable connection with power cable 1,5 m without end terminal
	DEVIconnecto B-E	Heating cable end terminal
	DEVIconnecto Bracket	For installation of the DEVIconnecto connection outside the insulation



### DEVIconnecto system installation steps

1. Cut the heating cable straight
2. Push the heating cable in
3. Twist until closed



## DEVIpipeguard™ 10 (T), DEVIpipeguard™ 25 (T), DEVIpipeguard™ 33 (T)

The DEVIpipeguard™ is a self-limiting heating cable that is mainly used for frost protection of pipes. The self-limiting capability of the cable ensures that the output of the cable increase or decrease according to ambient temperature. The cable will maintain its functionality even when shortened.

The polyolefin outer sheath is highly resistant to harsh environmental conditions and corrosion and it also serves as a protection against mechanical influences.

The cables are not approved for use in drinking water.

### Benefits:

- Cut to length on site
- PVC free

### Standard compliance:

- DIN VDE 0254: 1994-06

### Approvals:



Type	Value
Operation voltage	230 V AC
Nominal output: DEVIpipeguard™ 10 DEVIpipeguard™ 25 DEVIpipeguard™ 33	10 W/m @ 10 °C 25 W/m @ 10 °C 33 W/m @ 10 °C
Maximum permissible use temperature	65 °C, powered 85 °C, unpowered
Minimum installation temperature	-50 °C
Cable dimensions	13,6 × 5,8 mm
Outer sheath: DEVIpipeguard™ 10 DEVIpipeguard™ 25 DEVIpipeguard™ 33	Blue, TPE Red, TPE Grey, TPE
Screen	Tinned copper braid
Minimum braid coverage DEVIpipeguard™ 10, DEVIpipeguard™ 25 DEVIpipeguard™ 33	70% 80%
Maximum resistance protective braid	18,2 Ω/Km
Bending Ø, min.	64 mm (Ø to the inside of the tape)

### Types DEVIpipeguard™ 10

Item no.	Type	Length	Permissible length	EAN no.
98300863	DEVIpipeguard™ 10	Drum, 100 m	-10% to +10% (actual length on each reel)	5703466213513
98300864	DEVIpipeguard™ 10	Drum, 250 m		5703466213520
98300865	DEVIpipeguard™ 10	Drum, 750 m		5703466213537
98300845	DEVIpipeguard™ 10	Cut-to-length (up to 750 m)	-	5703466213933

### Types DEVIpipeguard™ 25

Item no.	Type	Length	Permissible length	EAN no.
98300866	DEVIpipeguard™ 25	Drum, 100 m	-10% to +10% (actual length on each reel)	5703466213544
98300867	DEVIpipeguard™ 25	Drum, 250 m		5703466213551
98300868	DEVIpipeguard™ 25	Drum, 750 m		5703466213568
98300846	DEVIpipeguard™ 25	Cut-to-length (up to 750 m)	-	5703466213940

### Types DEVIpipeguard™ 33

Item no.	Type	Length	Permissible length	EAN no.
98300869	DEVIpipeguard™ 33	Drum, 250 m	-10% to +10% (actual length on each reel)	5703466213575
98300847	DEVIpipeguard™ 33	Cut-to-length (up to 250 m)	-	5703466213957

RCD of 30 mA is required, max. 500 m of self-limiting heating cable per RCD.



### DEVipeguard™ 10 (T) heating cable maximum length

Start-Up Temp. (°C)	Breaker Size (C Type)				
	10 A (8 Max)	16 A (12,8 Max)	20 A (16 Max)	25 A (20 Max)	32A (25,6 Max)
-40	80	127	159	199	226
-30	87	140	175	219	226
-20	97	156	195	226	226
-10	110	176	220	226	226
0	119	191	226	226	226
10	119	191	226	226	226

### DEVipeguard™ 25 (T) heating cable maximum length

Start-Up Temp. (°C)	Breaker Size (C Type)				
	10 A (8 Max)	16 A (12,8 Max)	20 A (16 Max)	25 A (20 Max)	32A (25,6 Max)
-40	38	61	76	95	122
-30	42	67	84	105	134
-20	46	74	93	116	146
-10	52	84	105	131	146
0	58	93	116	146	146
10	58	93	116	146	146

### DEVipeguard™ 33 (T) heating cable maximum length

Start-Up Temp. (°C)	Breaker Size (C Type)				
	10 A (8 Max)	16 A (12,8 Max)	20 A (16 Max)	25 A (20 Max)	32A (25,6 Max)
-40	23	37	47	58	75
-30	25	41	51	64	82
-20	28	45	57	71	91
-10	32	51	64	81	103
0	36	58	73	91	117
10	42	67	84	105	120

### Heating power

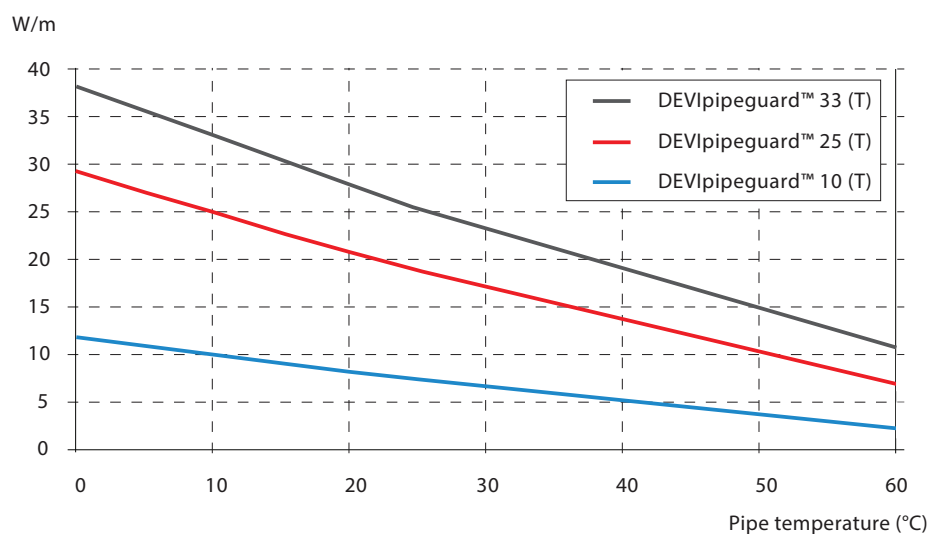

Output of heating cable installed and measured on a pipe.

## DEVI EasyConnect



DEVI EasyConnect is a system that enables you to connect your Thermon self-limiting heating cables - DEVliceguard™ (T), DEVlpipeguard™ (T) and modify your heat tracing circuit in 1 click.

You can use the EasyConnect indoors as well as outdoors. The connectors are IP 68 rated by VDE and CE marked. This 3 pole Connector is rated for 240 Volt and 20 Amps and can be used within a temperature range of -40° to 100°C.

The modular design allows a variety of combinations of the connections. The system is compatible with all types of Thermon DEVlpipeguard™ (T) and DEVliceguard™ (T) self-limiting heating cables.

### Benefits:

- Easy to install
- Cut to length on site
- High temperature cable

### Standard compliance:

- DIN VDE 0606 T200
- DIN EN 61984 (VDE 0627)
- VDE 0110 IEC 60999
- LR Type Approval System

### Approvals:



Connection sets	
Type	Value
Operation voltage, max.	250 V~
Max. current	16 A
Max. permissible use temperature	100 °C
Min. permissible use temperature	-40 °C
Power cable	3 x 2,5 mm <sup>2</sup>
Outer sheath	thermoplastic, PA66
Protection class	IP68 (2 hours in water 3 meters deep)
Seal	NBR (Nitrile Butadiene Rubber)
Waranty	5 years
Junction box (EC-JB4)	
Type	Value
Operation voltage, max.	250 V~
Max. current	16 A
Max. permissible use temperature	70 °C
Min. permissible use temperature	-20 °C
Outer sheath	PS (polystyrene)
Protection class	IP65
Waranty	5 years

### Types

Item no.	Type	Resistance	EAN no.
98300870	<b>DEVI EasyConnect EC-1</b>	Power supply connection set	5703466214503
98300875	<b>DEVI EasyConnect EC-2</b>	Power supply connection set for 2 cables	5703466214558
98300876	<b>DEVI EasyConnect EC-3</b>	Power supply connection set for 3 cables	5703466214565
98300872	<b>DEVI EasyConnect EC-ETK</b>	End plug set	5703466214527
98300873	<b>DEVI EasyConnect EC-1+ETK</b>	Power supply connection set with an end plug	5703466214534
98300871	<b>DEVI EasyConnect EC-T1</b>	Connection set for 2 heating cables	5703466214510
98300874	<b>DEVI EasyConnect EC-T2</b>	Set for heating cable branching – 1 to 2	5703466214541
98300877	<b>DEVI EasyConnect EC-JB4</b>	Junction box for connecting 4 heating cables - 1 to 4	5703466214572

**DEVI EasyConnect**

**EC-1 (98300870).**

Power supply connection set

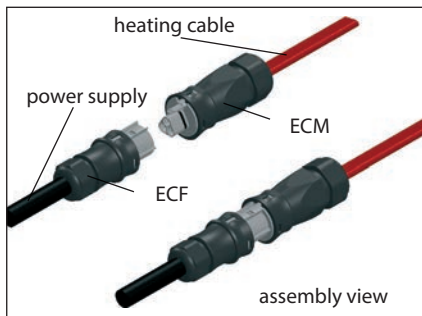

**EC-2 (98300875).**

Power supply connection set for 2 cables

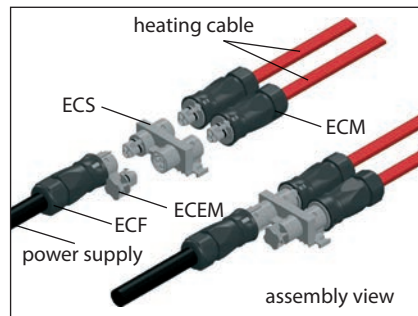

**EC-3 (98300876).**

Power supply connection set for 3 cables

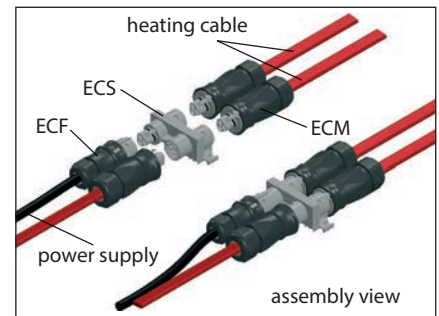

**EC-ETK (98300872).**

End plug set

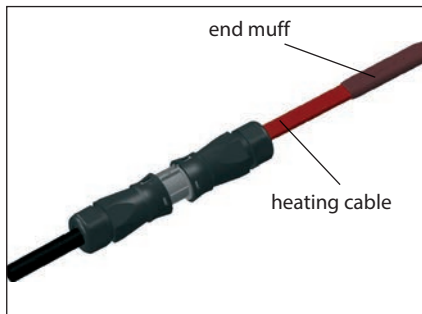

**EC-1 + ETK (98300873).**

Power supply connection set with an end plug

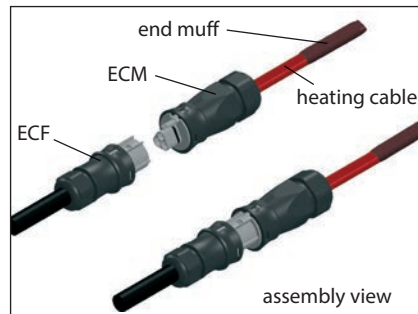

**EC-T1 (98300871).**

Connection set for 2 heating cables

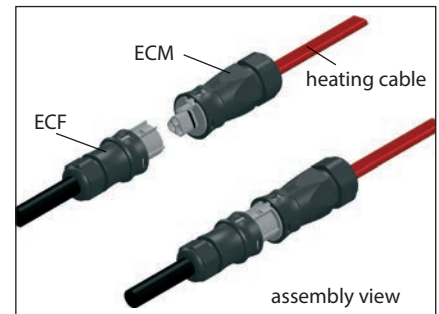

**EC-T2 (98300874).**

Set for heating cable branching - 1 to 2

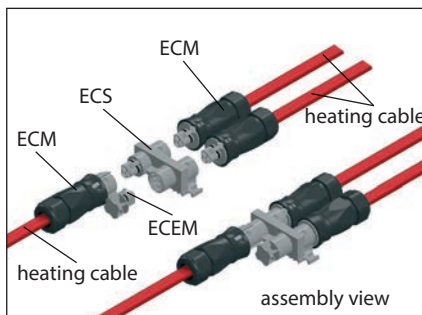

**Example of DEVI EasyConnect appliance**

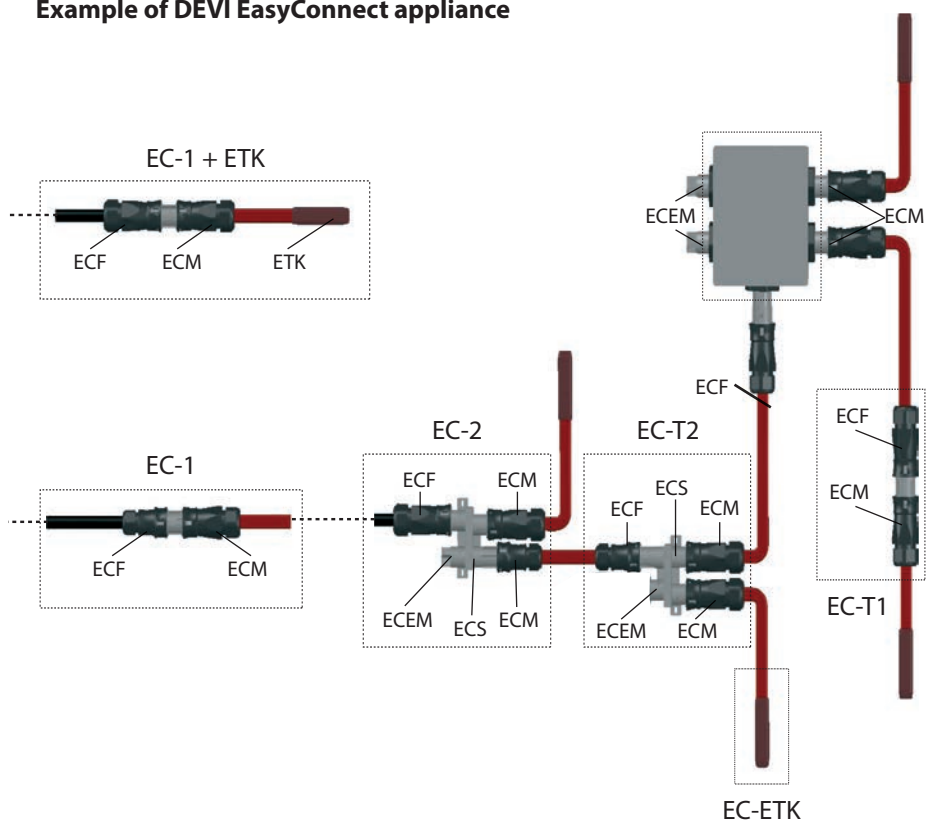

**EC-JB4 (98300877).**

Junction box for connecting 4 heating cables - 1 to 4

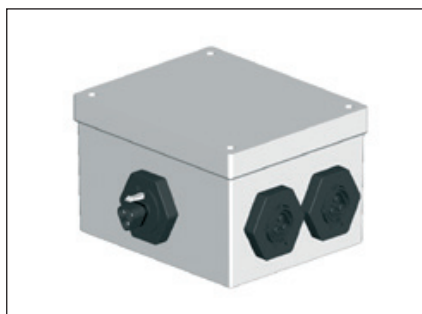

ECF - socket outlet (Female), ECM - socket plug (Male),  
ECEM - socket plug cover(Male), ECS - distribution block.



## DEVIpipeguard™ 30 Industry (PT-30), DEVIpipeguard™ 60 Industry (PT-60)

DEVIpipeguard™ Industry is a self-limiting heating cable that is mainly used for frost protection of pipes and for temperature maintenance in applications up to 120 °C powered or 190 °C unpowered cable.

The cable allows steam cleaning in pipes. The heating element, the insulation and the outer jacket of DEVIpipeguard™ Industry are made of fluoropolymers.

Fluoropolymer outer jacket offers increased protection against chemicals (oil and fuel) and abrasion.

A temperature-dependent resistance element between two parallel-guided copper conductors regulates and limits the heat output of the heating cable. This power setting takes place at every point of the heating cable, according to the ambient temperature prevailing there.

If the temperature rises, the power of the cable is reduced. This self-limiting prevents overheating of the cable, even if it is overlaid. The heating cable can be cut off at desired length by the parallel current supply. This simplifies planning and installation.

The installation of a thermostat is recommended.

The cable is not approved for use in drinking water.

Benefits:	Type	Value
<ul style="list-style-type: none"> <li>Cut to length on site</li> <li>PVC free</li> </ul>	Operation voltage	230 V AC (max. 254 V AC)
	Nominal output (min-max): DEVIpipeguard™ 30 Industry DEVIpipeguard™ 60 Industry	30 W/m @ 10 °C (30-39 W/m @ 10 °C) 60 W/m @ 10 °C (54-72 W/m @ 10 °C)
<b>Standard compliance:</b> <ul style="list-style-type: none"> <li>VDE E 0254: 94</li> </ul>	Maximum permissible use temperature	120 °C, powered 190 °C, unpowered
	Temperature rating conform IEC 60079-30	DEVIpipeguard™ 30 Industry – T3 DEVIpipeguard™ 60 Industry – T2
<b>Approvals:</b>  	Minimum installation and switched on temperature	-60 °C
	Cable dimensions	11,8 x 5,8 mm
	Outer sheath	Red, Fluoropolymer
	Minimum braid coverage	70 %
	Maximum resistance protective braid	18,2 Ω/Km
	Bending Ø, min.	50 mm (Ø to the inside of the tape)

### Types

Item no.	Type	Length	Min-max length per drum	Number of length allowed on drum, max	EAN no.
00109025	<b>DEVIpipeguard™ 30 Industry</b>	Drum, 270 m	270-330 m	1	5703466195673
98300673	<b>DEVIpipeguard™ 30 Industry</b>	Cut-to-length	1 m	-	5703466197257
00109027	<b>DEVIpipeguard™ 60 Industry</b>	Drum, 270 m	270-330 m	1	5703466163498
98300674	<b>DEVIpipeguard™ 60 Industry</b>	Cut-to-length	1 m	-	5703466197264

### Maximum heating circuit length on a pipe, with circuit breaker with C-characteristic

Switch on temperature	DEVipeguard™ 30 Industry				DEVipeguard™ 60 Industry			
	16 A	20 A	25 A	32 A	16 A	20 A	25 A	32 A
10 °C	85 m	114 m	114 m	114 m	50 m	64 m	64 m	64 m
-25 °C	69 m	92 m	100 m	114 m	38 m	52 m	58 m	64 m
-60 °C	65 m	86 m	92 m	110 m	35 m	48 m	52 m	60 m

### Power output characteristic

Output of heating cable installed and measured on a pipe.

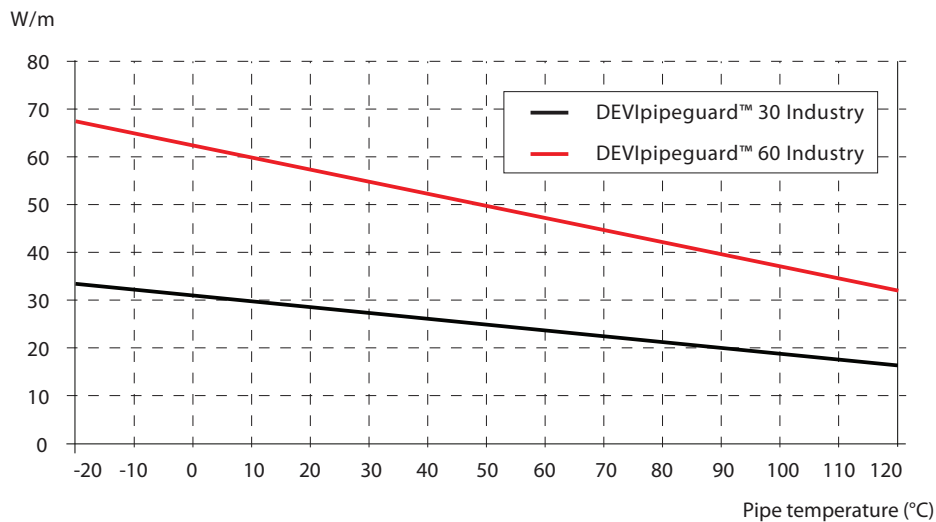

### Accessories

Item no.	EAN no.	Type	Description	Image
00109007	5703466167397	<b>Connection kit for DEVipeguard 30/60 Industry (PT-30/60) heating cables</b>	With clamping block for the connection of cold lead and heating cable, shrink end-cap, shrink tubes, bitumen gaskets and ferrules.	
00109026	5703466135778	<b>Connection kit for DEVipeguard 30/60 Industry (PT-30/60) heating cables</b>	For mounting in connection box with screw connections. With cable gland M20x1,5 with locknut, shrink end-cap, shrink tubes, bitumen gasket and ferrules.	
19400167	5703435002858	<b>Polyester box ABSC for DEVliceguard™ and DEVipeguard™</b>	For SLC (DEVliceguard, DEVipeguard)	
19405851	5703435002964	<b>Bracket</b>	Fitting for connection of housing (19400167) to pipes	
11010410	5703435031001	<b>Insulation introduction</b>	With mounting plate M20 60x60x1 mm AISI304; Cable gland U17 M20x1,5; Cable gland M25	
19805076	5703435003053	<b>Tape aluminium 38 mm x 50 m</b>	Self-adhesive, with 2-colour warning label, max. 75 °C	



## DEVIceguard™ 18 (B)

The DEVIceguard™ is a self-limiting parallel heating cable that is used for ice and snow melting on roofs and in gutters and downpipes.

The self-limiting capability of the cable ensures that the output of the cable increase or decrease according to ambient temperature.

The heating cable is flexible and easy to install as it can be cut to length at site and installed directly on to the roof and gutter system.

### Benefits:

- Easy to install
- **Cut to length on site**
- **Readymade lengths**

### Standard compliance:

- SS 4242411

### Approvals:



Type	Value
Operation voltage	230 V AC
Output	18 W/m @ 0 °C (15 W/m @ 10 °C)
Output (min-max)	15-20 W/m @ 0 °C
Maximum permissible use temperature	65 °C, powered 85 °C, unpowered
Minimum installation temperature	-50 °C
Cable dimensions	11,8 mm × 5,8 mm
Outer sheath	Black, TPE
Minimum braid coverage	80%
Maximum resistance protective braid	14,8 Ω/Km
Bending Ø, min.	50 mm (Ø to the inside of the cable)

### Types

Item no.	Type	Length	Min-max length per drum	Number of length allowed on drum, max	EAN no.
98300810	<b>DEVIceguard™ 18</b>	Drum, 100 m	100 m	1	5703466177198
98300809	<b>DEVIceguard™ 18</b>	Drum, 270 m	270-330 m	1	5703435005576
98300831	<b>DEVIceguard™ 18</b>	Drum, 720 m	720-880 m	2, between 100 & 880 m	5703466096581
98300827	<b>DEVIceguard™ 18</b>	Cut-to-length	1 m	-	5703466193372

### Construction

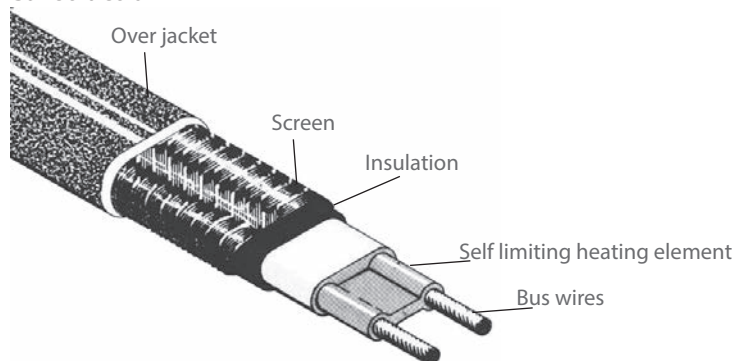

- Nickel plated copper bus wires
- Radiation Cross-Linked Semiconductive Heating Matrix
- Radiation Cross-Linked Primary Dielectric Insulation
- Tinned copper braid
- Polyolefin over jacket



**Maximum heating circuit length on a pipe, with circuit breaker with C-characteristic**

Switch on temperature	DEVliceguard™ 18			
	16 A	20 A	25 A	32 A
10 °C	145 m	162 m	162 m	162 m
-15 °C	93 m	125 m	142 m	162 m
-30 °C	77 m	106 m	135 m	160 m

**Heating power**

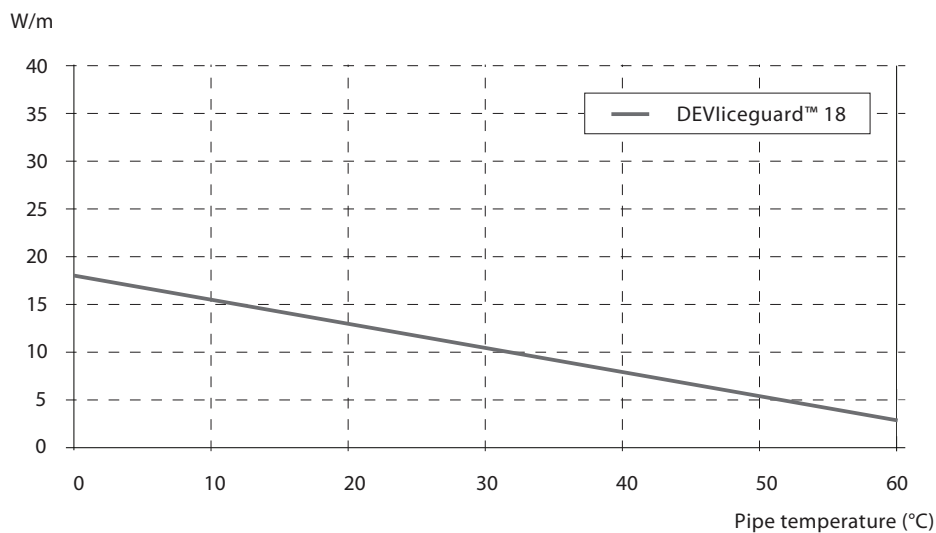



## DEVIceguard™ 18 (T)

The DEVIceguard™ is a self-limiting parallel heating cable that is used for ice and snow melting on roofs and in gutters and downpipes.

The self-limiting capability of the cable ensures that the output of the cable increase or decrease according to ambient temperature.

The heating cable is flexible and easy to install as it can be cut to length at site and installed directly on to the roof and gutter system.

### Benefits:

- Easy to install
- Cut to length on site
- Readymade lengths

### Standard compliance:

- SS 4242411

### Approvals:



Type	Value
Operation voltage	230 V AC
Nominal output	20 W/m @ 0 °C (18 W/m @ 10 °C)
Maximum permissible use temperature	65 °C, powered 85 °C, unpowered
Minimum installation temperature	-50 °C
Cable dimensions	11,3 × 5,8 mm
Outer sheath	Black, TPE
Minimum braid coverage	80%
Maximum resistance protective braid	14,8 Ω/Km
Cold lead DEVIceguard™ 18 Readymade	5 m DTWC, 2×1,5 mm <sup>2</sup> , screened
Bending Ø, min.	64 mm (Ø to the inside of the cable)

### Types DEVIceguard™ 18 Drum Goods

Item no.	Type	Length	Permissible length	Output @ 10 °C	EAN no.
98300860	DEVIceguard™ 18	Drum, 100 m	-10% to +10% (actual length on each reel)	18 W/m	5703466213483
98300861	DEVIceguard™ 18	Drum, 250 m		18 W/m	5703466213490
98300862	DEVIceguard™ 18	Drum, 750 m		18 W/m	5703466213506
98300844	DEVIceguard™ 18	Cut-to-length	-	18 W/m	5703466213926

### Types DEVIceguard™ 18 Readymade

Item no.	Type	Length	Output @ 10 °C	EAN no.
98300835	DEVIceguard™ 18 Readymade	2 m	36 W	5703466202678
98300836	DEVIceguard™ 18 Readymade	4 m	72 W	5703466202685
98300837	DEVIceguard™ 18 Readymade	6 m	108 W	5703466202692
98300838	DEVIceguard™ 18 Readymade	8 m	144 W	5703466202708
98300839	DEVIceguard™ 18 Readymade	10 m	180 W	5703466202715
98300840	DEVIceguard™ 18 Readymade	15 m	270 W	5703466202722
98300841	DEVIceguard™ 18 Readymade	23 m	414 W	5703466202739
98300842	DEVIceguard™ 18 Readymade	30 m	540 W	5703466202746
98300843	DEVIceguard™ 18 Readymade	50 m	900 W	5703466202753

### DEVliceguard™ 18 (T) heating cable maximum length in ice water

Start-Up Temp. (°C)	W/m	Breaker Size (C Type)				
		10 A (8 Max)	16 A (12,8 Max)	20 A (16 Max)	25 A (20 Max)	32A (25,6 Max)
-40	25	40	50	62	80	80
-30	27	44	55	69	88	88
-20	30	50	60	75	95	95
-10	34	54	68	85	95	95
0	38	60	75	94	95	95
10	51	82	103	129	129	129

### Output of heating cable installed and measured on pipe

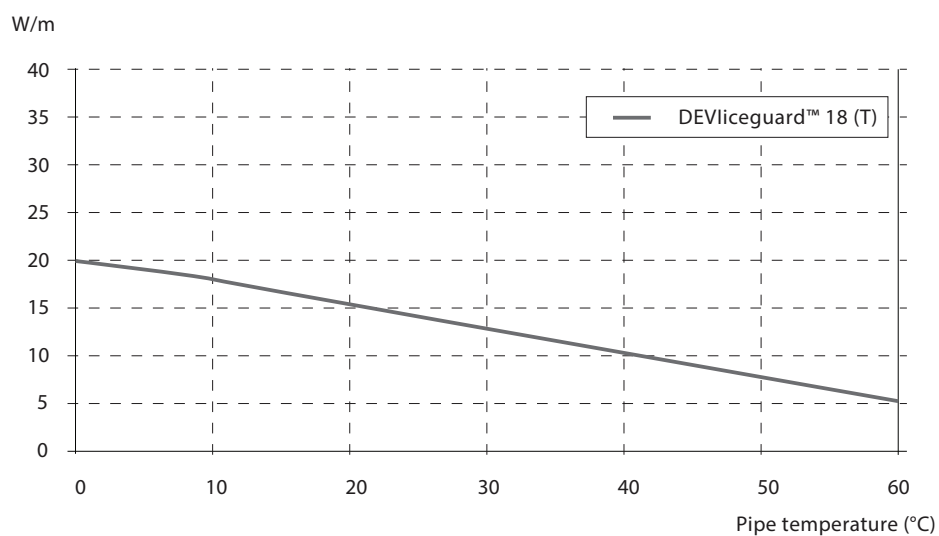

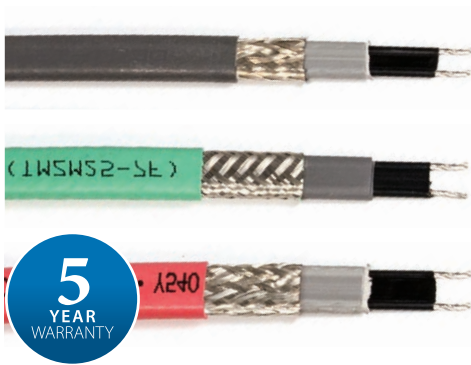

## DEVIhotwatt™ 45 (B), DEVIhotwatt™ 55 (B), DEVIhotwatt™ 70 (B)

The DEVIhotwatt™ is a self-limiting heating cable that is used for temperature maintenance of hot water supply and other fluids that need to maintain a certain temperature.

The self-limiting capability of the cable ensures that the output of the cable increase or decrease according to ambient temperature.

DEVIhotwatt™ ensures hot water in all taps and savings when circulation of the whole pipe system is unnecessary.

The cable is not approved for use in drinking water.

### Benefits:

- Cut to length on site
- Black version is UV protected
- PVC free

### Approvals:



Type	Value
Operation voltage	230 V AC
Nominal output (min-max) : DEVIhotwatt™ 45 DEVIhotwatt™ 55 DEVIhotwatt™ 70	7 W/m @ 45 °C (6,5-12,5 W/m @ 45 °C) 9 W/m @ 55 °C (8,5-15,8 W/m @ 45 °C) 12 W/m @ 70 °C (11,5-19,0 W/m @ 45 °C)
Outer sheath: DEVIhotwatt™ 45 DEVIhotwatt™ 55 DEVIhotwatt™ 70	Black, TPE Green, TPE Red, TPE
Maximum permissible use temperature	80 °C, powered 100 °C, unpowered
Minimum installation temperature	-50 °C
Cable dimensions	11,8 mm × 5,8 mm
Minimum braid coverage	70%
Maximum resistance protective braid	18,2 Ω/Km
Bending Ø, min.	50 mm (Ø to the inside of the tape)
Max. installation length - with 10 A circuit breaker	55 m

### Types DEVIhotwatt™ 45

Item no.	Type	Length	Min-max length per drum	Number of length allowed on drum, max	EAN no.
98300955	DEVIhotwatt™ 45	Drum, 270 m	270-330 m	1	5703466109144
98300718	DEVIhotwatt™ 45	Cut-to-length	1 m	-	5703466195925

### Types DEVIhotwatt™ 55

Item no.	Type	Length	Min-max length per drum	Number of length allowed on drum, max	EAN no.
98300958	DEVIhotwatt™ 55	Drum, 100 m	100 m	1	5703466177204
98300957	DEVIhotwatt™ 55	Drum, 270 m	270-330 m	1	5703435005613
98300956	DEVIhotwatt™ 55	Cut-to-length	1 m	-	5703466193389
140F1145	DEVIhotwatt™ 55	9 m	-	-	5703466240489
140F1146	DEVIhotwatt™ 55	25 m	-	-	5703466240496
140F1147	DEVIhotwatt™ 55	30 m	-	-	5703466240502
140F1148	DEVIhotwatt™ 55	55 m	-	-	5703466240519
140F1149	DEVIhotwatt™ 55	70 m	-	-	5703466240526
140F1150	DEVIhotwatt™ 55	15 m	-	-	5703466242919
140F1151	DEVIhotwatt™ 55	50 m	-	-	5703466242926
140F1152	DEVIhotwatt™ 55	80 m	-	-	5703466242933

### Types DEVIhotwatt™ 70

Item no.	Type	Length	Min-max length per drum	Number of length allowed on drum, max	EAN no.
98300959	DEVIhotwatt™ 70	270 m, drum	270-330 m	1	5703466109151
98300964	DEVIhotwatt™ 70	Cut-to-length	1 m	-	5703466193396

**Maximum heating circuit length on a pipe, with circuit breaker with C-characteristic**

Temperature	DEVIhotwatt™ 45				DEVIhotwatt™ 55				DEVIhotwatt™ 70			
	16 A	20 A	25 A	32 A	16 A	20 A	25 A	32 A	16 A	20 A	25 A	32 A
10 °C	165 m	189 m	189 m	189 m	135 m	160 m	160 m	160 m	120 m	140 m	140 m	140 m
-25 °C	117 m	152 m	170 m	189 m	100 m	130 m	145 m	160 m	88 m	120 m	130 m	140 m

**DEVIhotwatt™ cable heat emissions**

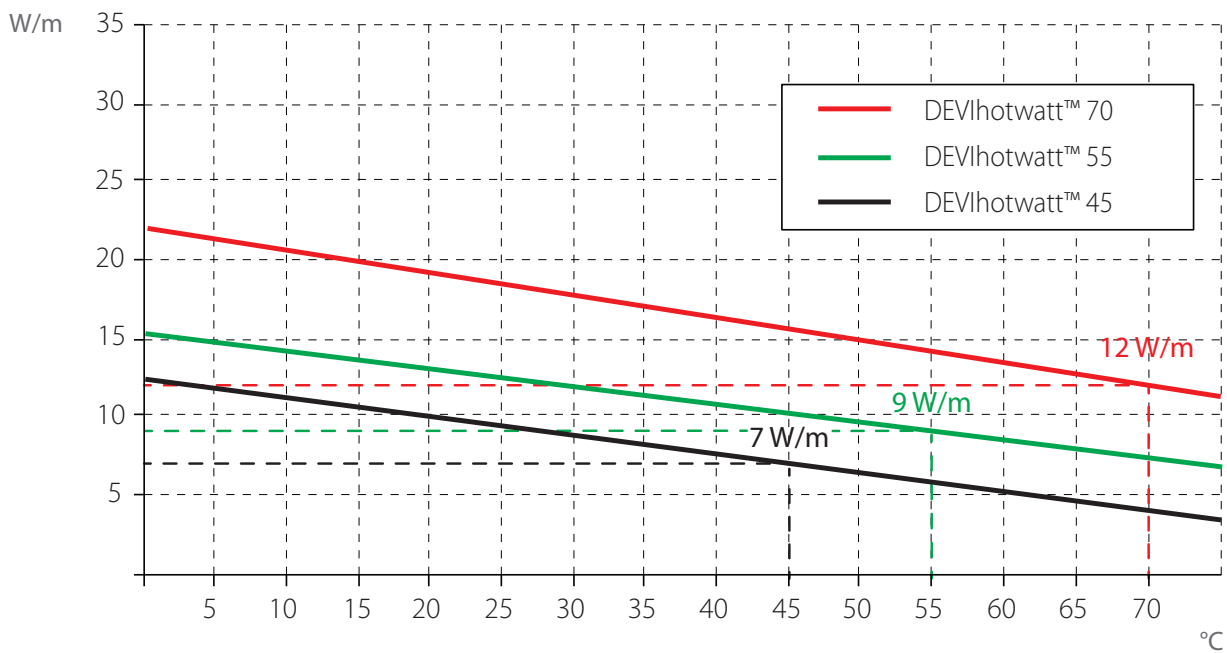

**Construction**

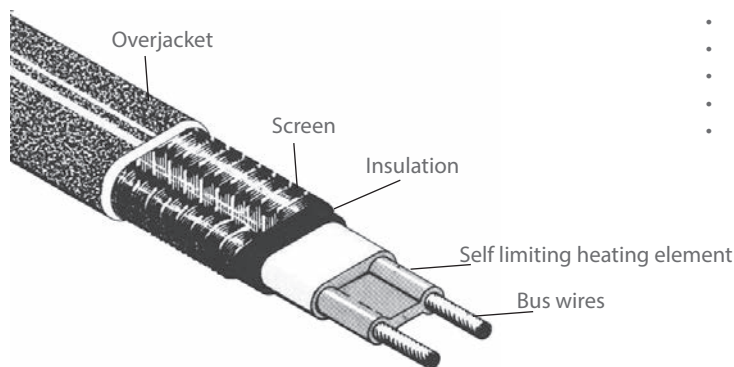

- Nickel plated copper bus wires
- Radiation Cross-Linked Semiconductive Heating Matrix
- Radiation Cross-Linked Primary Dielectric Insulation
- Tinned copper braid
- Polyolefin over jacket

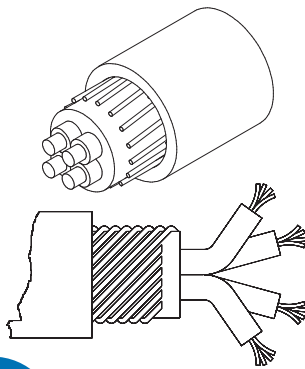

## DEVMulti™ PVC (DMIH), DEVMulti™ HDPE (DMIT)

DEVMulti™ is a high-quality, 4-conductor cable with an outer sheath made of PVC (DEVMulti™ PVC) or polyethylene HDPE (DEVMulti™ HDPE) and specially designed for frost protection of long pipes. Additionally cable is used in multiple outdoor ground, frost protection, etc., applications.

The cable is constructed of 4 identical conductors. The conductors can be connected in different ways (parallel and/or serial), meaning that the same cable can provide up to 11 different outputs, depending on the connection made.

DEVMulti™ PVC is very flexible and therefore perfectly suited for external installation on pipes, it can be supplied in 3 versions with different resistance values.

DEVMulti™ HDPE is very tough and therefore perfectly suited for internal installation in pipes, it can be supplied in 2 versions with different resistance values. **Note: DEVMulti™ HDPE must only be installed in water pipes, in concrete or inside environment without direct air contact.**

The cables are not approved for use in contact with water for human consumption.



DEVMulti™ can be customized for the specific project, depending on voltage, required output, length of heating cable and length of cold leads.



**Note:** It is the full responsibility of the installer/designer to use proper cold lead dimensioned for the purpose and assembly sets that establish sufficient mechanical strength, flammability resistance and water tightness - and to design the heating unit with correct output for the specific application to avoid overheating of the cable or building materials.

<b>Benefits:</b> <ul style="list-style-type: none"> <li>• Easy to install</li> <li>• Various Ohmic output</li> <li>• Safe and robust</li> <li>• Long life-time</li> </ul> <b>Standard compliance:</b> <ul style="list-style-type: none"> <li>• IEC 60800:1992</li> <li>• EN 50581:2012</li> </ul>	Type	Value	
	Operation voltage, max.		$U_o/U = 300/500 V\sim$
	Construction		4-conductor, round
	Max. permissible use temperature, powered		90 °C
	Max. permissible use temperature, unpowered		90 °C
	Cable dimensions, max.		Ø 8 mm
	Deformation strength, min.		120 N
	Pulling strength		-
	Conductor insulation		FEP
	Filler sheath		PVC
	Outer sheath: DEVMulti™ PVC DEVMulti™ HDPE		PVC, red HDPE, black
	Screen		1 mm <sup>2</sup> (16 x 0,286 mm)
	Min. installation temperature		0 °C
	Bending Ø, min.		50 mm
IP Class		IPX7	

### Types DEVMulti™ PVC (DMIH)

Item no.	Resistance	Conductor Ø	EAN no.
89999140	4 x 2,5 Ohm/m	0,96 mm	5703466039359
89999142	4 x 0,220 Ohm/m	0,771 mm	5703466039366
89999144	4 x 0,027 Ohm/m	1,02 mm	5703466039373

### Types DEVMulti™ HDPE (DMIT)

Item no.	Resistance	Conductor Ø	EAN no.
89999056	4 x 0,220 Ohm/m	0,771 mm	5703466024805
89999098	4 x 0,027 Ohm/m	1,02 mm	5703466024812

### Accessories

Item no.	Type	Description	EAN no.
19805712	<b>DEVicrimp assembly set DK 4-cond, type C</b>	Assembly set for 4-conductors cable for 2 connections: cold tail and end muff.*	5703466003855
19805480	<b>DEVicrimp assembly set DK 4-cond, type C</b>	Assembly set for 4-conductors cable for 1 connection: either cold tail or end muff.*	5703466003824
19805076	<b>Tape aluminium 38 mm x 50 m</b>	Self-adhesive, with 2-colour warning label, max. 75 °C	5703435003053
19805366	<b>3/4" + 1" Pipe fitting</b>	Fitting 3/4"+1" for DEVipeheat (DPH-10)	5703435041697

\* See full range of accessories with images on p. 113.



### Recommended maximum output per metre cable

Installation	Output, max
Molded in concrete	30 W/m
Mounted on plastic pipes below insulation with alufoil	10 W/m
Mounted on metal pipes below insulation with alufoil	20 W/m
Fitted in a drain pipe	15 W/m
Mounted in water pipes (enclosed by water)	30 W/m

Always remember thermostat control – sensor placed on / in media.

**Notice:** plastic pipes can melt at too high cable linear output and max. 10 W/m should be recommended.

### Cable construction

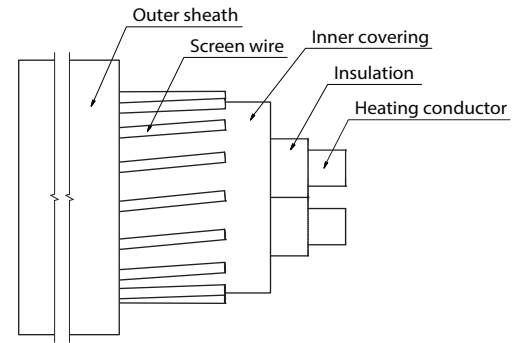

### Ohm values and lengths for couplings 1-11 with different outputs for for 4-conductor heating cable

**Coupling 1-10: 1 phase / 2 phase. Coupling 11: 3 phase (Y connection type).**

When designing and selecting the coupling method, ensure that the load is distributed equally between heat conductors as much as possible. Connection to one cable side marked "T" – twin, connection to two cable sides marked "S" – single.

Coupling diagrams	Rx = 0,027 Ohm/m						Rx = 0,22 Ohm/m						Rx = 2,5 Ohm/m						
	R <sub>Σ</sub> Ohm/m	p, W/m	230 V		400 V		R <sub>Σ</sub> Ohm/m	p, W/m	230 V		400 V		R <sub>Σ</sub> Ohm/m	p, W/m	230 V		400 V		
			L, m	P, W*	L, m	P, W*			L, m	P, W*	L, m	P, W*			L, m	P, W*	L, m	P, W*	
1 T	0,108	30	128	3833	222	6667	0,88	30	45	1343	78	2335	10	30	13,3	398	23,1	693	
			156	3130	272	5443			55	1096	95	1907			20	16,3	325	28,3	566
			181	2711	314	4714			63	950	110	1651			15	18,8	282	32,7	490
			221	2213	385	3849			78	775	135	1348			10	23,0	230	40,0	400
2 S	0,081	30	148	4426	257	7698	0,66	30	52	1551	90	2697	7,5	30	15,3	460	26,7	800	
			181	3614	314	6285			63	1266	110	2202			20	18,8	376	32,7	653
			209	3130	363	5443			73	1096	127	1907			15	21,7	325	37,7	566
			256	2556	444	4444			90	895	156	1557			10	26,6	266	46,2	462
3 S	0,0675	30	162	4849	281	8433	0,55	30	57	1699	98	2954	6,25	30	16,8	504	29,2	876	
			198	3959	344	6885			69	1387	121	2412			20	20,6	411	35,8	716
			229	3429	398	5963			80	1201	139	2089			15	23,8	356	41,3	620
			280	2799	487	4869			98	981	171	1706			10	29,1	291	50,6	506
4 T	0,054	30	181	5421	314	9428	0,44	30	63	1899	110	3303	5	30	18,8	563	32,7	980	
			221	4426	385	7698			78	1551	135	2697			20	23,0	460	40,0	800
			256	3833	444	6667			90	1343	156	2335			15	26,6	398	46,2	693
			313	3130	544	5443			110	1096	191	1907			10	32,5	325	56,6	566
5 T	0,0405	30	209	6260	363	10887	0,33	30	73	2193	127	3814	3,75	30	21,7	651	37,7	1131	
			256	5111	444	8889			90	1791	156	3114			20	26,6	531	46,2	924
			295	4426	513	7698			103	1551	180	2697			15	30,7	460	53,3	800
			361	3614	629	6285			127	1266	220	2202			10	37,6	376	65,3	653
6 T	0,036	30	221	6640	385	11547	0,2933	30	78	2326	135	4045	3,333	30	23,0	690	40,0	1200	
			271	5421	471	9428			95	1899	165	3303			20	28,2	563	49,0	980
			313	4695	544	8165			110	1645	191	2860			15	32,5	488	56,6	849
			383	3833	667	6667			134	1343	234	2335			10	39,8	398	69,3	693
7 T	0,027	30	256	7667	444	13333	0,22	30	90	2686	156	4671	2,5	30	26,6	797	46,2	1386	
			313	6260	544	10887			110	2193	191	3814			20	32,5	651	56,6	1131
			361	5421	629	9428			127	1899	220	3303			15	37,6	563	65,3	980
			443	4426	770	7698			155	1551	270	2697			10	46,0	460	80,0	800
8 S	0,0135	30	361	10842	629	18856	0,11	30	127	3798	220	6606	1,25	30	38	1127	65	1960	
			443	8853	770	15396			155	3101	270	5394			20	46	920	80	1600
			511	7667	889	13333			179	2686	311	4671			15	53	797	92	1386
			626	6260	1089	10887			219	2193	381	3814			10	65	651	113	1131
9 S	0,009	30	443	13279	770	23094	0,0733	30	155	4652	270	8090	0,8333	30	46	1380	80	2400	
			542	10842	943	18856			190	3798	330	6606			20	56	1127	98	1960
			626	9390	1089	16330			219	3289	381	5721			15	65	976	113	1697
			767	7667	1333	13333			269	2686	467	4671			10	80	797	139	1386
10 S	0,00675	30	511	15333	889	26667	0,055	30	179	5372	311	9342	0,625	30	53	1593	92	2771	
			626	12520	1089	21773			219	4386	381	7628			20	65	1301	113	2263
			723	10842	1257	18856			253	3798	440	6606			15	75	1127	131	1960
			885	8853	1540	15396			310	3101	539	5394			10	92	920	160	1600
11 TY	3x0,027 (0,009) Y type	30	256	7667	444	13333	3x0,027 (0,009) Y type	30	90	2686	156	4671	3x0,027 (0,009) Y type	30	26,6	797	46,2	1386	
			313	6260	544	10887			110	2193	191	3814			20	32,5	651	56,6	1131
			361	5421	629	9428			127	1899	220	3303			15	37,6	563	65,3	980
			443	4426	770	7698			155	1551	270	2697			10	46,0	460	80,0	800

**\*Notice:** Some cables have super high output and correct size of power cold lead should be chosen according to local norms and regulations. Normally do not allowed more than 10 A for a 1,5 mm<sup>2</sup> cold lead, 16 A for a 2,5 mm<sup>2</sup> cold lead.



## DEVlhightemp™ (DSIX)

Double insulated high-temperature silicone heating cable on drum.

Suitable for technological high-temperature heating. It has increased flexibility and can be used to protect the cold room doors from the freezing.

DEVlhightemp™ (DSIX) is manufactured as a single conductor heating cable without screen.

Contact with oil-containing medium is prohibited.

The cable is not approved for use in drinking water.

DEVlhightemp™ can be customized for the specific project, depending on voltage, required output, length of heating cable and length of cold leads.



**Note:** It is the full responsibility of the installer/designer to use proper cold lead dimensioned for the purpose and assembly sets that establish sufficient mechanical strength, flammability resistance and water tightness - and to design the heating unit with correct output for the specific application to avoid overheating of the cable or building materials.

### Benefits:

- Easy to install
- Cut to length on site
- High temperature cable

### Standard compliance:

- SS 4242411

### Approvals:



Type	Value
Operation voltage, max.	400 V~
Construction	Round, single conductor
Outer sheath	Double layer silicone insulation
Output, max.	40 W/m
Max. permissible use temperature, powered	170 °C
Minimum use temperature	- 51 °C
Cable dimensions	Ø 3,8 mm
Resistance tolerance	+7% ... -4%
Bending Ø, min.	20 mm

### Types

Item no.	Type	Resistance	EAN no.
03044336	DEVlhightemp™, cut-to-length	74 Ohm/m	5703464007169
03044542	DEVlhightemp™, cut-to-length	8,93 Ohm/m	5703464007176
03044609	DEVlhightemp™, cut-to-length	5,00 Ohm/m	5703464007190
03044633	DEVlhightemp™, cut-to-length	3,34 Ohm/m	5703464007206
03044666	DEVlhightemp™, cut-to-length	2,38 Ohm/m	5703466025123
03044757	DEVlhightemp™, cut-to-length	1,13 Ohm/m	5703464007237
03044781	DEVlhightemp™, cut-to-length	0,82 Ohm/m	5703466027271

### Accessories

Item no.	Type	EAN no.
86000080	Joining-kit for silicone cable	5703464006728
19805076	Tape aluminium 38 mm x 50 m, for cables, max. temp. 75 °C	5703435003053

### Calculated\* DEVIhightemp™ lengths for some specific outputs (W/m) and voltages

Resistance, r, Ohm/m	Specific output, p, W/m	12 V		24 V		230 V		400 V	
		Length, m	P, W	Length, m	P, W	Length, m	P, W	Length, m	P, W
74	40**	0,22	9	0,44	18	4,2	169	7,4	294
	30	0,25	8	0,51	15	4,9	146	8,5	255
	20	0,31	6	0,62	12	6,0	120	10,4	208
	10	0,44	4	0,88	9	8,5	85	14,7	147
8,93	40**	0,63	25	1,27	51	12,2	487	21,2	847
	30	0,73	22	1,47	44	14,1	422	24,4	733
	20	0,90	18	1,80	36	17,2	344	29,9	599
	10	1,27	13	2,54	25	24,3	243	42,3	423
5,00	40**	0,85	34	1,70	68	16,3	651	28,3	1131
	30	0,98	29	1,96	59	18,8	563	32,7	980
	20	1,20	24	2,40	48	23,0	460	40,0	800
	10	1,70	17	3,39	34	32,5	325	56,6	566
3,34	40**	1,0	42	2,1	83	19,9	796	34,6	1384
	30	1,2	36	2,4	72	23,0	689	40,0	1199
	20	1,5	29	2,9	59	28,1	563	48,9	979
	10	2,1	21	4,2	42	39,8	398	69,2	692
2,38	40**	1,2	49	2,5	98	23,6	943	41,0	1640
	30	1,4	43	2,8	85	27,2	817	47,3	1420
	20	1,7	35	3,5	70	33,3	667	58,0	1160
	10	2,5	25	4,9	49	47,1	471	82,0	820
1,13	40**	1,8	71	3,6	143	34,2	1368	59,5	2380
	30	2,1	62	4,1	124	39,5	1185	68,7	2061
	20	2,5	50	5,0	101	48,4	968	84,1	1683
	10	3,6	36	7,1	71	68,4	684	119,0	1190
0,82	40**	2,1	84	4,2	168	40,2	1606	69,8	2794
	30	2,4	73	4,8	145	46,4	1391	80,6	2419
	20	3,0	59	5,9	119	56,8	1136	98,8	1975
	10	4,2	42	8,4	84	80,3	803	139,7	1397

\*\* It's not recommended to use the heating cable with a maximum output - 40 W/m.

### \* Cable length calculation formulas

$$L = U / \sqrt{(p \cdot r)},$$

$$r = U^2 / (L^2 \cdot p),$$

$$p = U^2 / (L^2 \cdot r),$$

where

- L – length of heating cable (m);
- U – supply voltage (V);
- p – specific output (W/m);
- r – specific resistance (Ohm/m).

### Joining-kit for silicone cable (86000080)

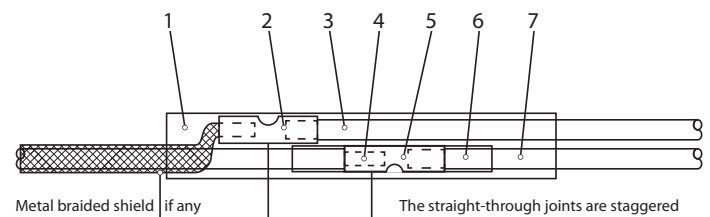

No.	Type	Qty.
1	Shrink hose MRWS 10/3, black	120 mm
2	Straight-through joint Ø 2,6 x Ø 4,2 x 15 mm CUFO	2 pcs.
3	Cable 1,5 q, yellow/green	1000 mm
4	Ending fitting 1,0 q, 6,0 mm Cu	2 pcs.
5	Straight-through joint Ø 1,9 x Ø 3,6 x 15 mm CUFO	2 psc.
6	Silicone hose Ø 3,0 mm	60 mm
7	Cord 1,0 q Cu, silicone insulated, red	1000 mm
8	Plastic bag 170 x 230 x 0,05 mm	1 pc.

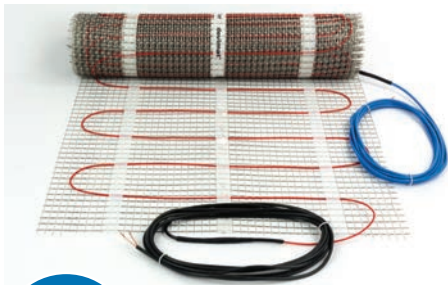

**20**  
YEAR  
WARRANTY

Product Installation Floor/Surface

## DEVI<sup>™</sup>mat DSVF-90

**DEVI<sup>™</sup>mat DSVF-90** is a single conductor heating mat for installation under artificial grass.

It is specially designed and configured for installation under artificial grass fields with the purpose of establishing frost protection. Though it is small, the sturdy heating element resists the continuous stress from players and vehicles.

**DEVI<sup>™</sup>mat DSVF-90** is tested for artificial grass with topdressing "Infillpro Geo" from Limonta Sport, Italy. If any other artificial grass type/producer is expected, please contact DEVI/Danfoss for testing underlay and top layer, including the specified top dressing, before the solution could be accepted.

### Benefits:

- Thin, only 3 mm including mesh
- Protective mesh
- Sturdy heating element
- Ø10 mm connection
- Other mat sizes on request

### Standard compliance:

- EN 60335-1
- EN 60335-2-96
- EN 50581

### Approvals:



Type	Value
Mat size	70,5 x 0,5 m Other mat length ±3 m on request
Output	90 W/m <sup>2</sup> @ 230 V~ (3245 W)
Nominal voltage	230 V~
Construction	Single conductor, round with screen, two cold leads
Cable diameter	2,5 mm
Cold tail	2 x 24 m, DSWA, 1 x 2,5 mm <sup>2</sup> with screen
Deformation strength, min.	600 N
Pulling strength, min.	120 N
Conductor insulation	FEP
Outer sheath	PVDF
Screen	10 x 0,25 mm Cu threads
Min. installation temperature	-5 °C
Max. permissible use temperature, powered	70 °C
Min. bending Ø	50 mm
IP Class	IPX7

### Types

Item no.	Output @ 230V~	Dimensions (W x L)	Area	Resistance	EAN no.
140F0399	3245 W	0,5 x 70,5 m	35,25 m <sup>2</sup>	16,3 Ω	5703466217344

### Accessories

Item no.	Description	EAN no.	
19805905	Synthetic nails, 100 pcs.	5703466061466	
19805908	Synthetic nails, 50 pcs.	5703466086902	



## Installation Step-by-step



1. Roll out and find the centre of the mat.



2. At the centre of the mat, cut the mesh - **not the cable**.

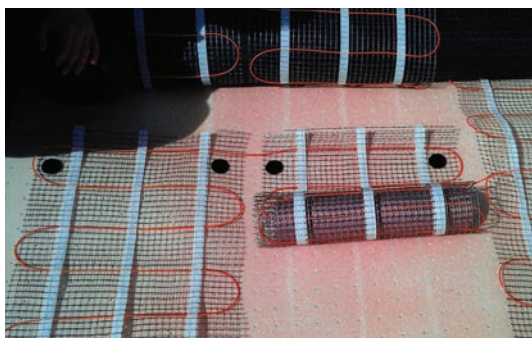

3. Secure the heating mat at the centre of the field, using the special carbon nails. Roll and stretch the mat towards the sideline.

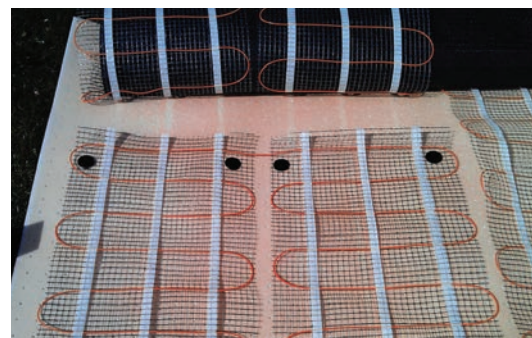

4. When reaching the side line secure the heating mat with the special carbon nails, one every 30 cm.



5. Remember to mark goal posts, corner flags, etc. to secure that the heating mat / cables are not damaged when making the holes for the posts.

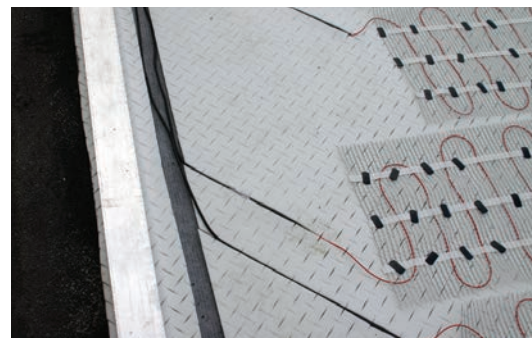

6. Cut a groove into the shock pad - **not the draining mat**, embed the cold leads and take them to the nearest cable vault.

## Installing the DEVImat™ DSVF-90

During installation of the heating mats an expert installation engineer must be present to supervise the installation and perform the required tests.

- Install the heating mat on top of the shock pad - **mesh up**.
- When rolling out the heating mat, secure the cold lead inside the cardboard tube of the roll in order for the cold lead not to be twisted.
- Mind that the cable does not drop down into the grooves in the shock pad.
- Do not step on the heating mats during installation.
- Use a rubber-headed hammer to secure the special carbon nails to the heating mat.
- Do not allow the heating mat to shift when laying out the artificial grass rolls.
- Do not use tools with sharp edges, do not use footwear with rough soles or similar, as this, in many cases, may damage the electrical heating mats.
- Only use the artificial grass for playing football.



**20**  
YEAR  
WARRANTY

Product Installation Floor/Surface

## DEVI sport™ (DSM3)

DEVI sport™ heating cable is the sturdy and cost effective single conductor heating cable for the major outdoor installations. The cable has a high mechanical strength both in relation to pulling and deformation making it ideal for installation with specialized cable ploughs.

The single conductor heating cable ensures an even heat generation and temperature distribution along the whole length of the cable.

DEVI sport™ can be customized for the specific project, depending on voltage, required output, length of heating cable and length of cold leads.



**Note:** It is the full responsibility of the installer/designer to use proper cold lead dimensioned for the purpose and assembly sets that establish sufficient mechanical strength, flammability resistance and water tightness - and to design the heating unit with correct output for the specific application to avoid overheating of the cable or building materials.

### Benefits:

- Sturdy cable
- Very high pulling strength
- High deformation strength
- Screened and IPX7

### Standard compliance:

- IEC60800:1992, NF-C 32-330

### Standard compliance:

- LCIE

Type	Value
Operation voltage	230 V~ or 400 V~
Construction	Round, single conductor with screen, 2 x cold lead
Output	20 W/m or 25W/m or 30W/m
Max. permissible use temperature, powered	65 °C @ 25 W/m
Max. permissible use temperature, unpowered	90 °C
Cable dimensions	Ø 8 mm
Deformation strength	1500 N
Pulling strength	1500 N
Conductor insulation	XLPE
Outer sheath	MDPE
Cold lead	DSWA + screen, at customized length
Min. installation temperature	-5 °C
Bending Ø, min.	6 x cable diameter (Ø)
IP Class	IPX7

### Types

Item no.	Resistance	Screen	EAN no.
84701442	0,040 Ω/m	16 x 0,40 mm <sup>2</sup> Cu	5703466058480
84701444	0,060 Ω/m	16 x 0,35 mm <sup>2</sup> Cu	5703466058497
84701446	0,085 Ω/m	16 x 0,30 mm <sup>2</sup> Cu	5703466058503
84701448	0,100 Ω/m	16 x 0,30 mm <sup>2</sup> Cu	5703466058510
84701450	0,150 Ω/m	16 x 0,30 mm <sup>2</sup> Cu	5703435021552
84701452	0,177 Ω/m	16 x 0,30 mm <sup>2</sup> Cu	5703466058527
84701454	0,255 Ω/m	16 x 0,30 mm <sup>2</sup> Cu	5703435021569
84701456	0,310 Ω/m	16 x 0,30 mm <sup>2</sup> Cu	5703466058534
84701458	0,339 Ω/m	16 x 0,30 mm <sup>2</sup> Cu	5703466058541
84701460	0,399 Ω/m	16 x 0,30 mm <sup>2</sup> Cu	5703466058558
84701462	0,624 Ω/m	16 x 0,30 mm <sup>2</sup> Cu	5703466058565
84701464	0,946 Ω/m	16 x 0,30 mm <sup>2</sup> Cu	5703466058572
84701466	1,600 Ω/m	16 x 0,30 mm <sup>2</sup> Cu	5703466058589
84701468	2,500 Ω/m	16 x 0,30 mm <sup>2</sup> Cu	5703466058596
84701470	4,430 Ω/m	16 x 0,30 mm <sup>2</sup> Cu	5703466058602
84701472	8,000 Ω/m	16 x 0,30 mm <sup>2</sup> Cu	5703466058619

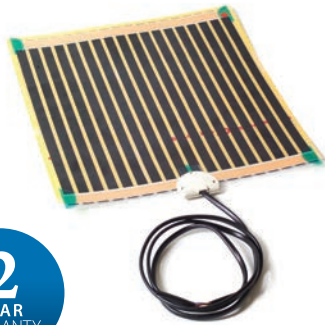

## DEVIfoil™ Mirror

An effective system for keeping the mirror completely steam free.

Fast and easy installation where the self-adhesive side of the heating foil is placed on the back of the mirror.

Low energy consumption and automatic activation when the light is switched on.

### Benefits:

- Fast and easy installation
- Low energy consumption
- Automatic activation

### Standard compliance:

- EN Norm BS EN 60335-1:2002 + Amd. 1 to 6
- BS EN 60335-2-30:2003 + Amd. 1 & 2

### Approvals:



Type	V alue
Operation voltage	230 V~
Output	200 W/m <sup>2</sup>
Max. ambient temperature	80 °C
IP Class	IP 44
Protection class	Class II - <input type="checkbox"/>
Connection cable length	95 cm

### Types

Item no.	Type	Dimensions	Wattage	EAN no.
62000000	<b>DEVIfoil™ Mirror 17,5</b>	274 x 358 mm	17,5 W	5703466180686
62000001	<b>DEVIfoil™ Mirror 40</b>	410 x 524 mm	40,0 W	5703466180693
62000002	<b>DEVIfoil™ Mirror 70</b>	708 x 524 mm	70,0 W	5703466180709



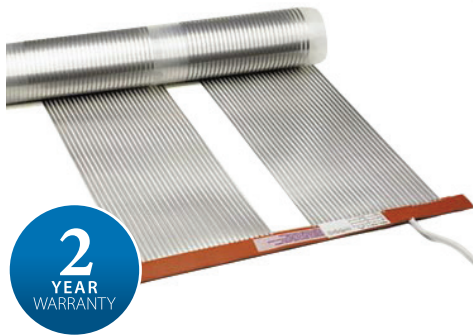

## DEVIfoil™ Ceiling

The **DEVIfoil™ Ceiling** heating foils are constructed of a live, special alloy, metal foil between two very resistant slip sheets. The melting point of the metal foil is lower than the melting point of the slip sheets resulting in a fireproof heating system.

In 30 cm intervals are conductor free fields that can be used for securing the foil.

The heating foils can be supplied in widths of 30 cm or 60 cm and in lengths up to 8,60 m.

### Benefits:

- Fast and easy to install
- Safe and robust
- Fireproof
- Long life-time

Type	Value
Operation voltage	220 - 240 V~
Output	100 W/m <sup>2</sup> or 150 W/m <sup>2</sup>
Insulation resistance	4000 V
Max. permissible use temperature	80°C
Foil thickness	0,2 mm
Cold lead	3 m, H 05 VV-F, 2 x 1.5 mm <sup>2</sup>

### Types

Item no.	Dimensions	Output	Area	EAN no.
98920051	0,3 x 3,60 m	135 W	1,08 m <sup>2</sup>	5703466187456
98920077	0,3 x 4,40 m	165 W	1,32 m <sup>2</sup>	5703466187463
98920101*	0,6 x 1,10 m	85 W	0,66 m <sup>2</sup>	5703466187470
98920135*	0,6 x 1,50 m	110 W	0,90 m <sup>2</sup>	5703466187487
98920168	0,6 x 2,20 m	165 W	1,32 m <sup>2</sup>	5703466187494
98920192	0,6 x 2,50 m	190 W	1,50 m <sup>2</sup>	5703466187500
98920226	0,6 x 2,95 m	220 W	1,77 m <sup>2</sup>	5703466187517
98920259	0,6 x 3,40 m	255 W	2,04 m <sup>2</sup>	5703466187524
98920283	0,6 x 3,80 m	285 W	2,28 m <sup>2</sup>	5703466187531
98920317	0,6 x 4,40 m	330 W	2,64 m <sup>2</sup>	5703466187548
98923006*	0,3 x 2,80 m	85 W	0,84 m <sup>2</sup>	5703466187555
98923048	0,3 x 5,00 m	150 W	1,50 m <sup>2</sup>	5703466187562
98923105	0,3 x 7,60 m	230 W	2,28 m <sup>2</sup>	5703466187579
98923121	0,3 x 8,60 m	260 W	2,58 m <sup>2</sup>	5703466187586
98923501*	0,6 x 1,40 m	85 W	0,84 m <sup>2</sup>	5703466187593
98923527*	0,6 x 1,95 m	115 W	1,17 m <sup>2</sup>	5703466187609
98923543	0,6 x 2,50 m	150 W	1,50 m <sup>2</sup>	5703466187616
98923568	0,6 x 2,80 m	170 W	1,68 m <sup>2</sup>	5703466187623
98923584	0,6 x 3,30 m	200 W	1,98 m <sup>2</sup>	5703466187630
98923600	0,6 x 3,80 m	230 W	2,28 m <sup>2</sup>	5703466187647
98923626	0,6 x 4,30 m	260 W	2,58 m <sup>2</sup>	5703466187654
98923642	0,6 x 5,00 m	300 W	3,00 m <sup>2</sup>	5703466187661
98923667	0,6 x 5,60 m	340 W	3,36 m <sup>2</sup>	5703466187678
98923683	0,6 x 6,60 m	400 W	3,96 m <sup>2</sup>	5703466112205
98923709	0,6 x 7,70 m	460 W	4,62 m <sup>2</sup>	5703466112212

\* Operation voltage 115 V.



## DEVIreg™ 527

**DEVIreg™ 527** is an electronic 15 Amps on/off time regulator with a 2-pole switch and for flush-mounted fixing. This regulator is best suited for installations in which it is impossible to install or replace a floor sensor.

**DEVIreg™ 527** does not require a sensor and does not regulate according to the temperature, it's a timer with 30 min cycle. The heating intervals (relay ON) can be set on a scale from 0 to 6, which corresponds to 0-100% of the 30 min cycle (100% = 30 min). Each dial position (from 0 to 6) corresponds to 5 minutes.

Furthermore, regulator has a LED indicator showing relay OFF (green light) and relay ON (red light) periods.

### Benefits:

- Double pole safety breaker
- Low standby consumption
- No sensor required

### Standard compliance:

- EN/IEC 60730-1

Type	Value
Operation voltage	220-240 V, 50 Hz
Standby power consumption	Max. 0,25 W
Relay:	
Resistive load	Max. 15 A (3450 W) @ 230 V
Inductive load	Max. 1 A, cos φ= 0,3
Ambient temperature	-10 °C to +30 °C
Cable specification max.	1x4 mm <sup>2</sup> or 2x2,5 mm <sup>2</sup>
Ball pressure test temperature	75 °C
Pollution degree	2 (domestic use)
Controller type	1C
IP class	IP 31
Protection class	Class II - <input type="checkbox"/>
Dimensions (H/W/D)	85 x 85 x 36 mm
Weight	90 g

### Types

Item no.	Product name	Type	EAN no.
140F1041	<b>DEVIreg™ 527</b>	ELKO frame, no sensor	5703466209103

### Connection scheme

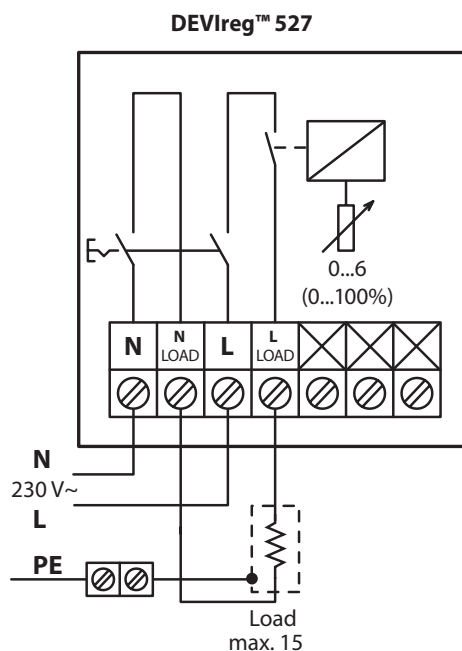



## DEVIreg™ 130, DEVIreg™ 132



**DEVIreg™ 130/132** is a line of simple electronic 16 Amps thermostats with possibility to be installed directly on the wall. The thermostats have only one button for adjusting the temperature and for OFF mode. Furthermore, it has an LED indicator showing standby (green light) and heating (red light) periods. The thermostats do not have wire sensor failure monitoring. Wire temperature sensor included in the set.

**DEVIreg™ 130** is equipped with a wire (floor) sensor used for control of Comfort Floor Heating applications. The thermostat has a dial for adjusting the temperature setting with a numeric scale from 0, ❄️ to 5 (meaning from OFF, 5 °C to 45 °C and each step corresponds to approx. 9 °C). This type of thermostat can be used for outdoor applications too – Ice and Snow Melting on Ground, Frost Protection on Roofs, Pipe Tracing, etc., because it doesn't have wire sensor failure monitoring.

**DEVIreg™ 132** is equipped with a built-in air sensor to control the room temperature and an additional floor (wire) sensor to limit the maximum floor temperature. The main application is Total (Direct) Heating via Floor systems. The thermostat has a dial for adjusting the room temperature, with a degree scale from 0, ❄️ to 35°C (which means from OFF, 5°C to 35°C). Adjusting maximum floor temperature is provided with potentiometer placed under front cover (default 35°C).

Benefits:	Type	Value
<ul style="list-style-type: none"> <li>• Double pole safety breaker</li> <li>• Sensor failure monitoring</li> <li>• LED indication</li> <li>• Frost protection</li> </ul>	Operation voltage	220 - 240 V, 50/60 Hz
	Standby power consumption	Max. 5 W
	Resistive load	Max 16 A (3680 W) @ 230 V
	Inductive load	Max. 1 A, cos φ = 0,3
<b>Standard compliance:</b> <ul style="list-style-type: none"> <li>• EN/IEC 60730-1 (general)</li> <li>• EN/IEC 60730-2-9 (thermostat)</li> </ul>	Hysteresis	± 0,2°C
	Ambient temperature	-10 °C to +30 °C
	Frost protection	5 °C - ❄️
	Cable specification max	1 x 4 mm <sup>2</sup> or 2 x 2,5 mm <sup>2</sup>
<b>Approvals:</b> 	Ball pressure test temperature	75°C
	Pollution degree	2 (domestic use)
	Controller type	1 C
	Storage temperature	-20 °C to +65 °C
	IP class	IP 30
	Protection class	Class II - 
	Dimensions (H/W/D)	82 x 82 x 36 mm
	Weight	90 g

### Types

Item no.	Product name	Temp. range	Sensor type	Marking	EAN no.
140F1010	<b>DEVIreg™ 130</b>	5-45 °C	Wire sensor, 3 m, NTC 15 kOhm at 25 °C	D130	5703466208953
140F1011	<b>DEVIreg™ 132</b>	Room: 5-35 °C, max. floor temp.: 20-50 °C (default 35 °C)	Built-in room sensor and wire sensor, 3 m, NTC 15 kOhm at 25 °C	D132	5703466208960

Connection schemes

DEVireg™ 130

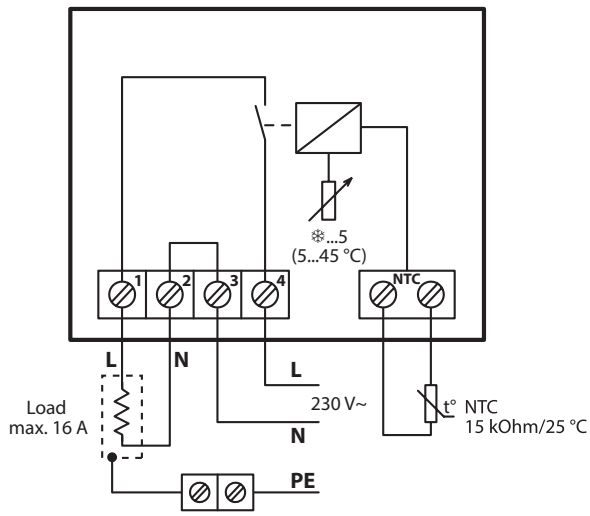

DEVireg™ 132

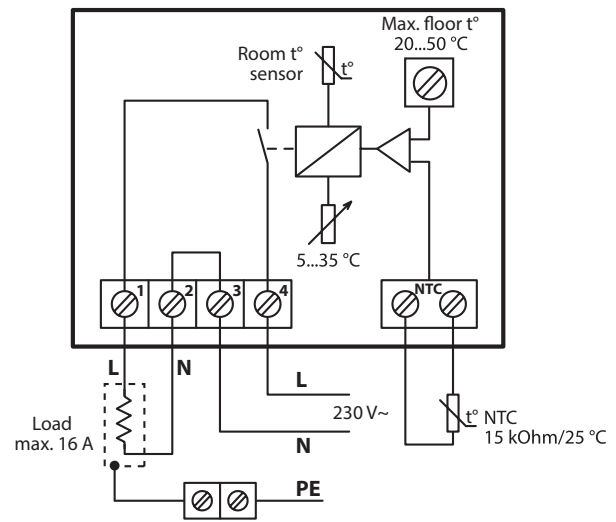



## DEVIreg™ 530, DEVIreg™ 531, DEVIreg™ 532, DEVIreg™ 528, DEVIreg™ 530M

**DEVIreg™ 528/530/530M/531/532** 532 is a line of simple electronic thermostats with a 2-pole switch and for flush-mounted fixing. The thermostats are used to control indoor floor heating systems.

**DEVIreg™ 530** is a 15 Amps thermostat with a wire (floor) sensor, used to control Comfort Floor Heating systems. The thermostat has a dial for adjusting the temperature setting with a numeric scale from ❄️ to 6 (meaning from 5 °C to 45 °C and each step corresponds to approx. 8 °C).

**DEVIreg™ 531** is a 15 Amps thermostat with a built-in air (room) sensor, used to control Direct Floor Heating systems. It has a dial for adjusting the temperature setting with a degree scale from ❄️ to 35 °C (meaning from 5 °C to 35 °C).

**DEVIreg™ 532** is a 15 Amps thermostat with a built-in air (room) sensor to control the room temperature and an additional floor (wire) sensor to limit the maximum floor temperature. The thermostat is used to control Direct Heating via Floor systems with limitation of maximum floor temperature in wooden floors and other heat sensitive floors. It has a dial for adjusting the room temperature, with a degree scale from ❄️ to 35 °C (meaning from 5 °C to 35 °C). Adjusting of the maximum floor temperature is provided by potentiometer placed under front cover (default 35 °C).

**DEVIreg™ 528** is a 10 Amps thermostat with a floor (wire) sensor to measure and control the desired floor temperature. The thermostat has a dial for adjusting the temperature setting with a scale from ❄️ to 6 (from 5 °C to 45 °C).

**DEVIreg™ 530M** is a 15 Amps thermostat with max. floor temperature 35 °C and a 2-pole switch to be installed directly on the wall, using a floor(wire) sensor to measure and control the desired floor temperature (max. 35 °C). The thermostat has a dial for adjusting the temperature setting with a scale from ❄️ to 6 (from 5 °C to 35 °C).

The thermostats have a LED indicator showing standby (green light) and heating (red light) periods. Furthermore, they have a wire sensor failure monitoring - flashing green light - and switch off the heating, if the sensor is disconnected or short-circuited.

### Benefits:

- 2-pole safety breaker
- Low standby consumption
- Sensor failure monitoring
- LED indication for fault
- Frost protection

### Standard compliance:

- EN/IEC 60730-1 (general)
- EN/IEC 60730-2-9 (thermostat)

### Approvals:



Type	Value
Operation voltage	220 - 240 V, 50/60 Hz
Standby power consumption	Max. 0,25 W
Resistive load: DEVIreg™530/ 531/532/530M DEVIreg™ 528	Max 15 A (3450 W) @ 230 V Max 10 A (2300 W) @ 230 V
Inductive load	Max. 1 A, cos φ = 0,3
Hysteresis	± 0,4 °C
Sensing unit	NTC 15 kOhm at 25 °C
Ambient temperature	-10 °C to +30 °C
Frost protection	5 °C - ❄️
Cable specification max	1 x 4 mm <sup>2</sup> or 2 x 2,5 mm <sup>2</sup>
Ball pressure test temperature	75 °C
Pollution degree	2 (domestic use)
Controller type	1 C
Storage temperature	-20 °C to +65 °C
IP class	IP 31
Protection class	Class II - 
Dimensions (H/W/D)	85 x 85 x 36 mm
Weight	90 g

## Types

Item no.	Product name	Frame	Temperature range	Sensor type	Marking	EAN no.
140F1030	DEVIreg™ 530	ELKO	5-45 °C	Wire sensor, 3 m, NTC 15 kOhm at 25 °C	D530	5703466208991
140F1031	DEVIreg™ 530	ELJO	5-45 °C	Wire sensor, 3 m, NTC 15 kOhm at 25 °C	D530	5703466209004
140F1032	DEVIreg™ 530	JUSSI	5-45 °C	Wire sensor, 3 m, NTC 15 kOhm at 25 °C	D530	5703466209011
19150352	DEVIreg™ 530	10 pcs. pack JUSSI	5-45 °C	Wire sensor, (3 m, NTC 15 kOhm at 25 °C)	D530	5703466152829
19150354	DEVIreg™ 530	10 pcs. pack ELKO	5-45 °C	Wire sensor, (3 m, NTC 15 kOhm at 25 °C)	D530	5703466159248
140F1034	DEVIreg™ 531	ELKO	5-35 °C	Built-in room sensor	D531	5703466209035
140F1036	DEVIreg™ 531	JUSSI	5-35 °C	Built-in room sensor	D531	5703466209059
140F1037	DEVIreg™ 532	ELKO	5-35 °C room temperature; 20-50 °C floor temperature limiter (default 35 °C)	Built-in room sensor and wire sensor, (3 m, NTC 15 kOhm at 25 °C)	D532	5703466209066
140F1039	DEVIreg™ 532	JUSSI	5-35 °C room temperature; 20-50 °C floor temperature limiter (default 35 °C)	Built-in room sensor and wire sensor, (3 m, NTC 15 kOhm at 25 °C)	D532	5703466209080
140F1042	DEVIreg™ 528	JUSSI	5-45 °C	Wire sensor, 3 m, NTC 15 kOhm at 25 °C	D528	5703466208991
140F1043	DEVIreg™ 528	ELKO	5-45 °C	Wire sensor, 3 m, NTC 15 kOhm at 25 °C	D528	5703466209004
19150350	DEVIreg™ 528	10 pcs. pack JUSSI	5-45 °C	Wire sensor, (3 m, NTC 15 kOhm at 25 °C)	D528	5703466209011
140F1101	DEVIreg™ 530M	ELKO	15-35 °C	Wire sensor, 3 m, NTC 15 kOhm at 25 °C	D530M	5703466210406

## Connection schemes

DEVIreg™ 530

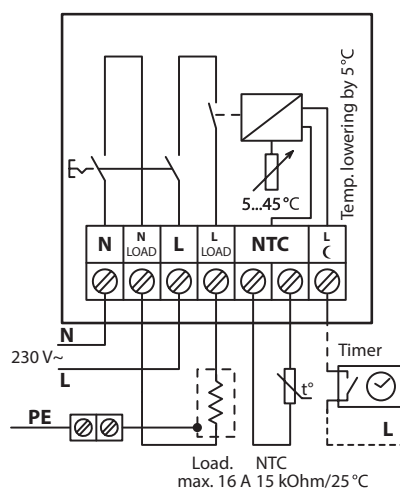

DEVIreg™ 531

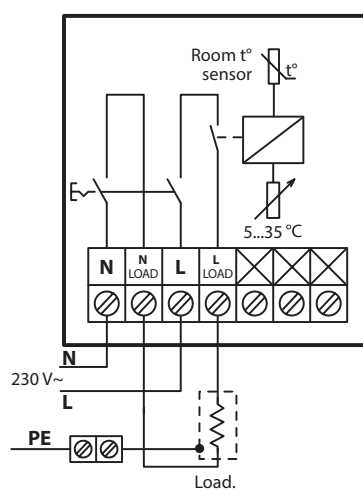

DEVIreg™ 532

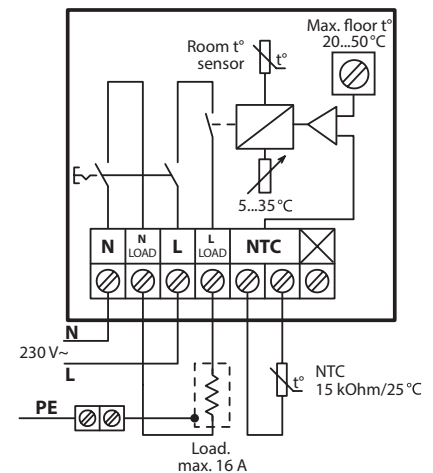



## DEVIreg™ Touch

The **DEVIreg™ Touch** is an intuitive programmable timer thermostat used for controlling electrical floor heating elements. The thermostat is designed for fixed installation only and due to the special designed 2-part construction it fits a wide range of frames and sensors.

The **DEVIreg™ Touch** is fast and intuitive to setup using the built-in wizard. It has an energy-saving programme – including an optimum start/end control ensuring the desired temperature at the correct time and thereby reducing the heating costs.

### Benefits:

- Big 2" touch screen
- Built-in setup wizard
- Easy and intuitive functionalities
- Adaptive PWM function
- Fits several single and multiple frames
- Fits several competitor NTC sensors
- Optional code setup
- Easy online troubleshooting

### Standard compliance:

- EN/IEC 60730-1 (general)
- EN/IEC 60730-2-9 (thermostat)

### Approvals:



Type	Value
Operation voltage	220 V- 240V~ 50/60 Hz
Standby power consumption	max. 0.40 W
Relay:	
Resistive load	16A / 3680W @ 230V
Inductive load	Cos Φ = 0.3 max. 1A
Sensing unit	NTC 15 kΩ @ 25°C, 3 m. (default), NTC 6.8 kΩ @ 25°C, NTC 10 kΩ @ 25°C, NTC 12 kΩ @ 25°C, NTC 33 kΩ @ 25°C, NTC 47 kΩ @ 25°C
Regulation	PWM - Pulse Width Modulation
Ambient temperature	0°C. to 30°C.
Frost protection	5°C. to 9°C. (default 5°C. )
Floor temperature limit	Max. 20°C. to 35°C. (45°C.) Min. 10°C. to 35°C. (45°C.)
Temperature range	5°C. to 35°C. (room) 5°C. to 45°C. (floor)
Storage temperature	-20°C. to 65°C.
Cable specification max.	1 x 4 mm <sup>2</sup> or 2 x 2.5 mm <sup>2</sup>
Ball pressure test temperature	75°C.
Pollution degree	2 (domestic use)
Controller type	1 C
Software class	A
IP class	21
Protection class	Class II - <input type="checkbox"/>
Dimensions (H/W/D)	85 mm x 85 mm x 20-24 mm (in-wall depth: 22 mm)
Weight	115 g

### Types

Item no.	Product name	Type	Language	EAN no.
140F1065	<b>DEVIreg™ Touch - Pure White</b>	Frameless RAL 9010	1	5703466215142
140F1064	<b>DEVIreg™ Touch - Pure White</b>	Design Frame RAL 9010	1	5703466215135
140F1068	<b>DEVIreg™ Touch - Pure White</b>	Design Frame RAL 9010	2	5703466225592
140F1071	<b>DEVIreg™ Touch - Polar White</b>	Design Frame RAL 9016	1	5703466225615
140F1069	<b>DEVIreg™ Touch - Pure Black</b>	Design Frame RAL 9005	1	5703466225608
140F1078	<b>DEVIreg™ Touch - Ivory</b>	Design Frame RAL 1013	1	5703466235492

1 - Contains languages: Bulgarian, Czech, Danish, English, Estonian, Finnish, French, German, Latvian, Lithuanian, Norwegian, Polish, Romanian, Russian, Slovenian, Slovak, Swedish, Ukrainian.

2 - Contains languages: Chinese, Croatian, Dutch, English, Hungarian, Italian, Portuguese, Serbian, Spanish, Turkish.





## DEVIreg™ Smart

The DEVIreg™ Smart is an intuitive programmable timer thermostat to be connected to WIFI and DEVIsmart™ App controllable from anywhere, at any time. The thermostat is primarily used for controlling electrical floor heating elements. The thermostat is designed for fixed installation only and due to the special designed 2-part construction it fits a wide range of frames and sensors.

The DEVIreg™ Smart is fast and intuitive to setup using the App wizard. It has an open window detector and energy-saving program including an optimum start/end control ensuring the desired temperature at the correct time and thereby reducing the heating costs.

### Benefits:

- WIFI Connectivity
- Remote Controllable via DEVIsmart™ App
- A single DEVIreg™ Smart thermostat can be paired with up to 10 mobile devices using DEVIsmart™ App
- Can communicate with two mobile devices simultaneously
- With one DEVIsmart™ App you are able to control as many locations with as many DEVIreg™ Smart thermostats as you need
- Adaptive PWM function
- Fits many foreign single and multiple frames
- Fits many foreign competitive NTC sensors

### Standard compliance:

- EN/IEC 60730-1 (general)
- EN/IEC 60730-2-9 (thermostat)
- EN 300 328 (WIFI)

### Approvals:



Type	Value
Operation voltage	220 V- 240V~ 50/60 Hz
Standby power consumption	max. 0,40 W
Relay:	
Resistive load	16A / 3680W @ 230V
Inductive load	1A (Cos Φ = 0,3)
Sensing unit	NTC 15 kΩ @ 25°C, 3 m. (default), NTC 6,8 kΩ @ 25°C, NTC 10 kΩ @ 25°C, NTC 12 kΩ @ 25°C, NTC 33 kΩ @ 25°C, NTC 47 kΩ @ 25°C
Regulation	PWM - Pulse Width Modulation
Ambient temperature	0°C to 30°C
Frost protection	5°C to 9°C (default 5°C)
Floor temperature limit	Max. 20°C to 35°C (45°C) Min. 10°C to 35°C (45°C)
Temperature range	5°C to 35°C (room) 5°C to 45°C (floor)
Storage temperature	-20°C to 65°C
Cable specification max.	1 x 4 mm <sup>2</sup>
Ball pressure test temperature	75°C
Pollution degree	2 (domestic use)
Controller type	1 C
Software class	A
IP class	21
Protection class	Class II - <input type="checkbox"/>
Dimensions (H/W/D)	85 mm x 85 mm x 20-24 mm (in-wall depth: 22 mm)
Weight	127 g
DEVIsmart™ App	1 App can control up to 100 thermostats 10 Apps can be connected to 1 thermostat 2 Apps can control one thermostat at the same time

### Types

Item no.	Product name	Type	EAN no.
140F1140	DEVIreg™ Smart - Polar White	RAL 9016	5703466239629
140F1141	DEVIreg™ Smart - Pure White	RAL 9010	5703466239636
140F1142	DEVIreg™ Smart - Ivory	RAL 1013	5703466239643
140F1143	DEVIreg™ Smart - Pure Black	RAL 9005	5703466239650



Try it!  
Download the  
DEVIsmart™ App





## DEVIlink™ CC

**DEVIlink™ CC** – Central Controller, is the perfect solution for the regulation of electric floor heating both for apartments, family houses and multifamily buildings.

DEVIlink™ is Danfoss Link™ App enabled, that offers you the unique possibility to control your electrical heating systems from a distance via an App on your smartphone.

**The DEVIlink™ CC** (Central Controller) is the central brain in the DEVIlink™ system, which includes several wireless DEVIlink™ devices installed in the building. The idea of the DEVIlink™ System is to link together your heating system wirelessly and control it from one central point. The DEVIlink™ CC communicates wirelessly with all other DEVIlink™ units in the installation. A single DEVIlink™ CC can control up to 30 rooms and be connected up to totally 50 devices

### Benefits:

- Central control of the entire house
- Minimize energy consumption
- Vacation mode
- Controlling of ON/OFF devices
- Weekly heating schedule
- WIFI connectivity Enabled for Danfoss Link™ App

### Standard compliance:

- The DEVIlink™ CC is in compliance with EN 60730 and EN 300 220-2

### Certificates:



Type	Value
Operation voltage	15 V DC ±10%
Standby power consumption	Max. 2 W
Screen	3.5" TFT colour w. touch
Ambient temperature	-10 to +40°C
Storage temperature	-20 to +65°C
Ball pressure test temperature	75°C
Pollution degree	2 (domestic use)
Transmission frequency	868.42 MHz
Transmission range	Up to 30 m
Max. repeaters in a chain	3
Transmission power	Max. 1 mW
Software class	A
IP class	21
Dimensions	125 x 107 x 25 mm
Weight	179 g

### Types

Item no.	Product name	Type	EAN no.
140F1135	<b>Devilink™ CC</b>	Permanent Installation	5703466238967

### Accessories

Item no.	Product name	Type	EAN no.
014G0262	<b>BSU DEVIlink™ CC</b>	Battery Supply Unit	5702420110653

### DEVIlink™ system units

Item no.	Product name	Type	EAN no.
140F1136	<b>Devilink™ RS</b>	Room sensor - Wireless - Battery Supply	5703466238974
140F1137	<b>Devilink™ FT</b>	Floor Thermostat with ELKO frame	5703466238981
140F1138	<b>Devilink™ RU</b>	Repeater Unit	5703466238998

See how simple it is to setup Wi-Fi on your DEVIlink system and how to pair it with the Danfoss Link™ App.



**Try it!**  
Download the  
Danfoss Link™ App





## DEVIlink™ FT

DEVIlink™ FT – Floor Thermostat with sensor to control electric floor heating. Optionally also able to function as ON/OFF devices switching. The DEVIlink™ FT is a device for switching heating elements and other electrically equipment ON/OFF. All communication in the DEVIlink™ System is wireless and of this reason very easy to install. When using DEVIlink™ FT as heating control, it is recommended to install the device with a floor sensor to ensure the required comfort and convenience. Optionally the DEVIlink™ FT is also able to be used as ON/OFF switch for other electrical equipment e.g. as electrical radiators, lights or other switching units.

### Benefits:

- Heating regulation
- ON/OFF switching
- Wireless connected to DEVIlink™ CC
- Daily/Weekly overview
- Daily/Weekly schedule
- Minimize energy consumption

### Standard compliance:

- EN 60730
- EN 300 220-2

### Certificates:



Type	Value
Operation voltage	180-250 V AC, 50 Hz
Standby power consumption	< 1W
Resistive load	230 V ~ 15 A/3450 W
Inductive load	Cos Φ = 0,3 max. 4 A
Regulation	PWM – Pulse Wide Modulation
Sensing unit	NTC 15 kOhm AT 25°C
Sensing values	
• 0°C	42 kOhm
• 20°C	18 kOhm
• 50°C	6 kOhm
Ambient temperature	-10° to +30°C
Sensor failure monitoring	The thermostat has a built-in monitoring circuit, which will switch off the heating if the sensor is disconnected or short circuited
Transmission frequency	868,42 MHz
Transmission range in normal buildings	Up to 30 m
Transmission power	Max. 1 mW
Relay switching	1 pole
IP class	31
Dimension (H/W/D)	85 mm × 85 mm × 21 mm

### Types

Item no.	Product name	Type	EAN no.
140F1137	<b>Devilink™ FT</b>	Floor Thermostat with ELKO frame	5703466238981

### DEVIlink™ system units

Item no.	Product name	Type	EAN no.
140F1135	<b>Devilink™ CC</b>	Permanent Installation	5703466238967
140F1136	<b>Devilink™ RS</b>	Room sensor - Wireless - Battery Supply	5703466238974
140F1138	<b>Devilink™ RU</b>	Repeater Unit	5703466238998

IMPORTANT: When the thermostat is used to control a floor heating element in connection with a wooden floor or similar material, always use a floor sensor and never set the maximum floor temperature to more than 35°C.



## DEVIlink™ RS

DEVIlink™ RS is a Room Sensor for precise measuring and setting of room temperature values, that shall be installed together with a DEVIlink™ FT to secure the required comfort and convenience. It is a battery operated device for measuring room temperature. High flexibility through free positioning

### Benefits:

- Heating regulation
- Wireless connected to DEVIlink™ CC
- Actually temperature view
- Adjustable
- Daily overview
- Weekly schedule
- Minimize energy consumption

### Standard compliance:

- EN 60730
- EN 300 220-25

### Certificates:



Type	Value
Battery	Alkaline 2 × AA, 1,5 V
Battery Lifetime	Up to 4-5 years
Backlight	Green LED
Ambient temperature	0° to +40°C
Battery monitoring	The sensor has a built-in monitoring circuit, which will detect low or critical battery level.
Transmission frequency	868,42 MHz
Transmission range in normal buildings	Up to 30 m
Transmission power	Max. 1 mW
IP class	21
Dimension (H/W/D)	81 mm × 66 mm x 21 mm

### Types

Item no.	Product name	Type	EAN no.
140F1136	<b>Devilink™ RS</b>	Room sensor - Wireless - Battery Supply	5703466238974

### DEVIlink™ system units

Item no.	Product name	Type	EAN no.
140F1135	<b>Devilink™ CC</b>	Permanent Installation	5703466238974
140F1137	<b>Devilink™ FT</b>	Floor Thermostat with ELKO frame	5703466238981
140F1138	<b>Devilink™ RU</b>	Repeater Unit	5703466238998

Do not install floor heating systems without a floor sensor when the heating element is installed on or beneath wooden surfaces and other surfaces sensitive to temperature!



## DEVIlink™ RU

DEVIlink™ RU – Repeater Unit is used for extending the wireless transmission range between DEVIlink™ CC Controller, DEVIlink™ RS Room thermostats, DEVIlink FT and other devices in DEVIlink™ system. This may be necessary because of a weak radio link caused by widely spread installations, large distances, metal objects, special structural conditions, etc.

The system supports up to three Repeater Units installed in a chain between the relevant DEVIlink™ Room thermostat and the DEVIlink™ CC Controller. More parallel chains of Repeater Units from a Controller are possible.

<p><b>Benefits:</b></p> <ul style="list-style-type: none"> <li>• Transmitting signals</li> <li>• Wireless connected to DEVIlink CC</li> <li>• Extending the wireless transmission range</li> </ul> <p><b>Standard compliance:</b></p> <ul style="list-style-type: none"> <li>• EN60730</li> </ul> <p><b>Certificates:</b></p> 	Type	Value	
	Operating voltage	180-250VAC, 50 Hz	
	Transmission frequency	868,42 MHz	
	Transmission range in normal buildings	Up to 30 m	
	Transmission power	<1 mW	
	Protection class	IP 21	
	Length of mains cable	3 m	
	Dimension (H/W/D)	81 mm x 66 mm x 21 mm	

### Types

Item no.	Product name	Type	EAN no.
140F1138	<b>DEVIlink™ RU</b>	Repeater Unit	5703466238998

### DEVIlink™ system units

Item no.	Product name	Type	EAN no.
140F1135	<b>DEVIlink™ CC</b>	Permanent Installation	5703466238967
140F1137	<b>DEVIlink™ FT</b>	Floor Thermostat with ELKO frame	5703466238981
140F1136	<b>DEVIlink™ RS</b>	Room sensor - Wireless - Battery Supply	5703466238974

Do not install floor heating systems without a floor sensor when the heating element is installed on or beneath wooden surfaces and other surfaces sensitive to temperature!



## DEVIreg™ 233

The **DEVIreg™ 233** is an electronic thermostat designed to be flush-mounted or wall-mounted in an installation box from the LK FUGA series. The thermostat is provided with a 1- pole switch and a floor sensor (wire) to measure and control the desired floor temperature. Alternatively an external room sensor can be used.

The thermostat has a button to adjust the temperature setting with a scale from (0) 1 to 6.

### Benefits:

- Fits LK FUGA frames
- Sensor failure monitoring
- LED indication
- Room and floor sensors
- Frost protection

### Standard compliance:

- EN/IEC 60730-1 (general)
- EN/IEC 60730-2-9 (thermostat)

### Approvals:



Type	Value
Operation voltage	220 V- 240V~ 50/60 Hz
Standby power consumption	Max. 1.7 W
Relay:	
Resistive load	Max 13A / 2990W @ 230V
Inductive load	Cos Φ = 0.3 max. 1A
Sensing unit	NTC 15 kOhm at 25°C
Hysteresis	± 0.4°C
Ambient temperature	0°C. to +40°C
Frost protection	5°C - ❄️
Temperature range	5°C to 45°C
Cable specification max	1 x 4 mm <sup>2</sup> or 2 x 2,5 mm <sup>2</sup>
Ball pressure test temperature	75°C
Pollution degree	2 (domestic use)
Controller type	1 C
Storage temperature	-20°C to +65°C
IP class	41 (vertical installation)
Protection class	Class II - <input type="checkbox"/>
Dimensions (H/W/D)	71 mm x 44 mm x 31 mm (in-wall depth: 20 mm)
Weight	77 g

### Types

Item no.	Product name	Type	EAN no.
140F1020	<b>DEVIreg™ 233</b>	With floor sensor	5703466208984
19112321	<b>DEVIreg™ 233</b>	With room sensor, white front button	5703466168981





## DEVIreg™ 330



**DEVIreg™ 330** is a line of simple electronic thermostats to be installed in electric cabinets with DIN rail attachment. To measure and control the desired temperature either a wire sensor (in the set) or an external indoor/outdoor air sensor must be used. The thermostat must be installed via an all-pole disconnection switch. It has a LED indicating showing standby (green light) and heating (red light) periods.

DEVIreg™ 330 has a relay with 2 contact pairs - NO (normally opened) and NC (normally closed), and are supposed to be used for heating and cooling systems. Additionally, NO and NC contact pairs are not wetted by a voltage source inside the thermostats, and can be used for control systems with any voltage up to 250 V.

The series is designed with thermostats in three temperature range.

**DEVIreg™ 330 (-10 - +10°C)** is used primarily for controlling a lower temperature range such as frost protection. This thermostat has a button to adjust the temperature setting with a scale from -10 °C to +10 °C. Special outdoor white wire sensor included in a set.

**DEVIreg™ 330 (5 - 45°C)** is used primarily for controlling lower temperature range such as frost protection and for cooling, Comfort Floor Heating, Total (Direct) Floor Heating, Ice and Snow Melting on Ground, Frost Protection on Roofs, Pipe Tracing, etc. The thermostat has a button to adjust the temperature setting with a scale from 5 °C to 45 °C. This type has temperature lowering in economy periods mode by using external timer.

**DEVIreg™ 330 (60 - 160°C)** is used primarily for high temperature maintenance in pipe heating systems. The thermostat has a button to adjust the temperature setting with a scale from 60 °C to 160 °C. Special high temperature silicon wire sensor in a set.

<b>Benefits:</b> <ul style="list-style-type: none"> <li>• For DINrail mounting</li> <li>• Low temperature area</li> <li>• Low standby consumption</li> <li>• LED indicator</li> </ul> <b>Standard compliance:</b> <ul style="list-style-type: none"> <li>• EN/IEC 60730-1 (general)</li> <li>• EN/IEC 60730-2-9 (thermostat)</li> </ul> <b>Approvals:</b>	Type	Value
	Operation voltage	220 - 240 V, 50/60 Hz
	Standby power consumption	Max. 0,25 W
	Resistive load	Max 16 A (3680 W) @ 230 V
	Inductive load	Max. 1 A, cos φ = 0,3
	Ambient temperature	-10 °C to +50 °C
	Cable specification max	1 x 4 mm <sup>2</sup> or 2 x 2,5 mm <sup>2</sup>
	Storage temperature	-20 °C to +65 °C
	IP class	20
	Protection class	Class II -
Dimensions (H/W/D)	85 x 36 x 58 mm	
Weight	83 g	

### Types

Item no.	Product name	Temp. range	Sensor type	Night setback	Hysteresis	Marking	EAN no.
140F1072	<b>DEVIreg™ 330 (5 - 45 °C)</b>	5 °C to 45 °C	Wire sensor, 3 m, NTC 15 kOhm at 25 °C	5 °C	± 0,2 °C	D330	5703466209226
140F1070	<b>DEVIreg™ 330 (-10 - +10 °C)</b>	-10 °C to +10 °C	Wire sensor, 3 m, NTC 15 kOhm at 25 °C	-	± 0,2 °C	D330	5703466209219
140F1073	<b>DEVIreg™ 330 (60 -160 °C)</b>	60 °C to 160 °C	Wire sensor, silicone, 3 m, NTC 16,7 kOhm at 100 °C	-	± 0,4 °C	D330	5703466209233

### Accessories

Item no.	Product name	Description	EAN no.
140F1095	<b>Room sensor, 426-frame</b>	85 x 85 x 30 mm, NTC 15 kOhm at 25 °C, IP 20	5703466209684
140F1096	<b>Outdoor sensor IP44</b>	80 x 50 x 35 mm, NTC 15 kOhm at 25 °C, IP 44	5703466209691
140F1091	<b>Sensor cable 3 m, 15 kOhm, Santropene</b>	Wire sensor, 2x0,75 mm <sup>2</sup> , NTC 15 kOhm at 25 °C, Ø5 mm, black Santropene (TPV) outer sheath, IP 67	5703466209301
19121445	<b>Sensor cable 40 m, 15 kOhm, Santropene</b>		5703466115015
140F1092	<b>Outdoor sensor 2,5 m, 15 kOhm, PVC</b>	Wire sensor, 2x0,75 mm <sup>2</sup> , NTC 15 kOhm at 25 °C, Ø8 mm, white PVC outer sheath, IP 67	5703466209318
140F1098	<b>Outdoor sensor 10 m, 15 kOhm, PVC</b>		5703466210734
140F1097	<b>Silicon temperature sensor for DEVIreg™ 330 (60-160°C), NTC 16,7 kOhm @ 100°C</b>	Wire sensor, 2,5 m, 2x0,75 mm <sup>2</sup> , NTC 16,7 kOhm at 100 °C, IP 65	5703466209707

**Connection scheme**

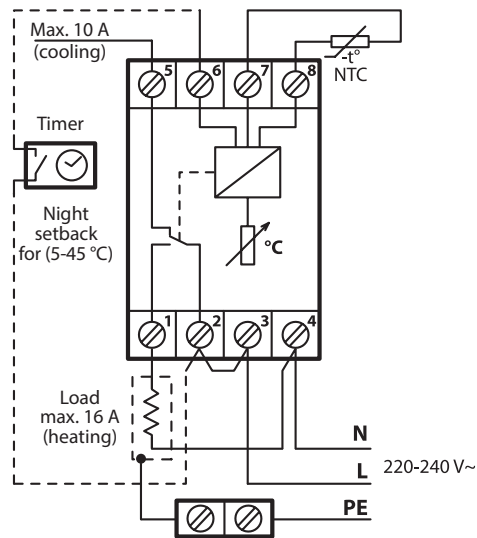

DEVIreg™ 330 (5 - 45 °C)



DEVIreg™ 330 (-10 - +10 °C)



DEVIreg™ 330 (60 - 160 °C)





## DEVIreg™ 316

The **DEVIreg™ 316** is a simple electronic thermostat with enhanced functionality which can be installed in electric cabinets with DIN rail attachment. The thermostat is mainly used for frost protection on roofs, in gutters and downpipes. Additionally it can be used to control room and floor temperature, ventilation, cooling or to the control of snow melting on ground, pipe tracing and similar installations. The main features of the thermostat is temperature range mode – with setting both an upper and a lower temperatures in between which the thermostat allows the system to heat. This mode is used primarily for controlling Frost Protection systems on roofs, in gutters and downpipes (an external outdoor air sensor must be used).

The thermostat is equipped with 2 additional buttons to adjust the hysteresis and the temperature value for leveraging in economy periods (an external timer must be used).

The thermostat has relay with 2 contact pairs - NO (normally opened) and NC (normally closed), and it is supposed to use thermostat for heating and cooling systems. Additionally NO and NC contact pairs are not wetted by a voltage source inside thermostat and can be used for control systems with any voltage up to 250 V.

It is designed so that the sensor circuit is galvanically separated from the high voltage part.

### Benefits:

- Night set-back
- Minimum temperature limiter
- Adjustable hysteresis
- DIN rail attachment
- Low standby consumption
- Large scope of application
- Protective separation

### Standard compliance:

- EN/IEC 60730-1 (general)
- EN/IEC 60730-2-9 (thermostat)

### Certificates:



Type	Value
Operation voltage	220 - 240V~ 50/60 Hz
Standby power consumption	max. 0,25 W
Resistive load	Max. 16 A, 3680 W @ 230 V
Inductive load	max. 1 A, cos φ = 0.3
Hysteresis	0 °C to 6 °C
Ambient temperature	-10 °C to +45 °C
Lowering in economy periods	0 °C to 8 °C
Temperature range	-10 °C to +50 °C
Minimum temperature range	-10 °C to +5 °C
Controller type	1 B
Storage temperature	-20 °C to +65 °C
IP class	IP 30
Protection class	Class II - <input type="checkbox"/>
Dimensions (H/W/D)	85 x 36 x 58 mm
Weight	180 g
Marking	D316

### Types

Item no.	Product name	Temperature range	Sensor type	EAN no.
140F1075	DEVIreg™ 316	-10 °C to +50 °C	Wire sensor, 3 m, NTC 15 kOhm at 25 °C	5703466209240

### Thermostat connection scheme

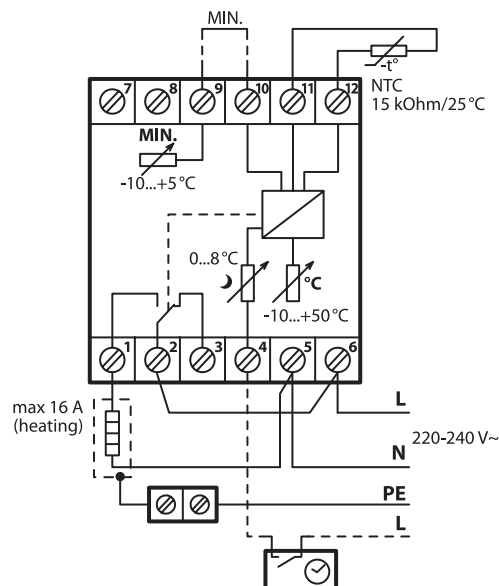



## DEVIreg™ 610

The DEVIreg™ 610 is an electronic IP44, 10 Amps thermostat, suitable for many different purposes both indoor and outdoor applications. It is provided with a 2-pole switch and a wire sensor to control the desired temperature.

The thermostat has a button for adjusting the temperature setting with a scale from -10 °C to +50 °C, and a LED indicating the current mode (heating, standby or fault).

It is water resistant and can be mounted on any plain surface indoor or outdoor.

### Benefits:

- ON/OFF switch
- Terminals for NO/NC connection
- LED indicator
- Mounts directly onto plain surfaces
- Low energy consumption
- IP44

### Standard compliance:

- EN/IEC 60730-1 (general)
- EN/IEC 60730-2-9 (thermostat)

### Approvals:



Type	Value
Operation voltage	220 V - 240 V, 50/60 Hz
Standby power consumption	max. 0,93 W
Relay:	
Resistive load	Max 10 A (2300 W) @ 230V
Inductive load	Max. 1A, Cos Φ = 0,3
Sensing unit	NTC 15 kOhm at 25 °C
Hysteresis	± 0,2 °C
Ambient temperature	-30 °C to +55 °C
Temperature range	-10 °C to +50 °C
Cable specification max	1 x 4 mm <sup>2</sup> or 2 x 2,5 mm <sup>2</sup>
Ball pressure test temperature	75°C
Pollution degree	2 (domestic use)
Controller type	1 C
Storage temperature	-20°C to +65°C
IP class	IP 44
Protection class	Class II - 
Dimensions (H/W/D)	100 mm x 69,5 mm x 45 mm
Weight	165 g

### Types

Item no.	Product name	Type	EAN no.
140F1080	DEVIreg™ 610	Temp. range -10 °C/+50 °C incl. wire sensors	5703466209257

IMPORTANT: When the thermostat is used to control a floor heating element in connection with a wooden floor or similar material, always use a floor sensor and never set the maximum floor temperature to more than 35°C.

## DEVIreg™ 850



The DEVIreg™ 850 is an advanced thermostat with LED display used for outdoor ground or roof applications. The sensors provide information about both moisture level and temperature, resulting in an optimal control of the heating system.

The system can be set up in three ways; as a single system for roof or ground (1 to 4 sensors), as a dual system for roof or ground (2 - 4 sensors) or as a combination system for roof and ground (2 - 4 sensors).

In the dual / combination systems it is possible to prioritize between the zones, e.g. if only a limited power output is available.

### Benefits:

- Single, combination or dual zones
- Up to 4 sensors
- Moisture and temperature sensing
- Self diagnosing programme
- Safety level adjustment
- Alarm function

### Standard compliance:

- EN/IEC 60730-1 (general)
- EN/IEC 60730-2-9 (thermostat)

### Approvals:



Type	Value
Operation voltage	220 - 240 V, 50/60 Hz
Standby power consumption	max. 0,93 W
Relay:	
Resistive load	Max 15 A (3450 W) @ 230 V
Inductive load	Max. 1 A, Cos Φ = 0,3
Sensing unit	DEVIbus™ connected moisture sensor(s)
Hysteresis	± 0,2 °C
Ambient temperature	-10 °C to +50 °C
Temperature range	-10 °C to +50 °C
Cable specification max	1 x 4 mm <sup>2</sup> or 2 x 2,5 mm <sup>2</sup>
Ball pressure test temperature	75 °C
Pollution degree	2 (domestic use)
Controller type	1 C
Storage temperature	-20 °C to +65 °C
IP class	IP 20
Protection class	Class II - <input type="checkbox"/>
Dimensions (H/W/D)	105 mm x 23.5 mm x 53 mm
Weight	720 g

### Types

Item no.	Product name	Type	EAN no.
140F1084	<b>DEVIreg™ 850</b>	RU/UA without sensors (Cyrilic)	5703466210833
140F1085	<b>DEVIreg™ 850</b>	Without sensors	5703466209264

### Accessories

Item no.	Product name	Type	Power	Size, mm	Operation temperature	EAN no.
140F1086	<b>Roof sensor</b>	For DEVIreg™ 850, cable - 15 m	8 W	15 x 24 x 216	-50...+70 °C	5703466209271
140F1087	<b>Ground sensor, 2 pcs</b>	For DEVIreg™ 850, cable - 15 m	13 W	Ø 93 x 98	-30...+70 °C	5703466209288
140F1088	<b>Ground sensor</b>	For DEVIreg™ 850, cable - 15 m	13 W	Ø 93 x 98	-30...+70 °C	5703466209714
R5722103	<b>Power Supply Unit</b>	DC-PSU, 24V/24W, DIN-rail	24 W	53 x 86 x 73	-10...+40 °C	5703466209721

## Connection scheme

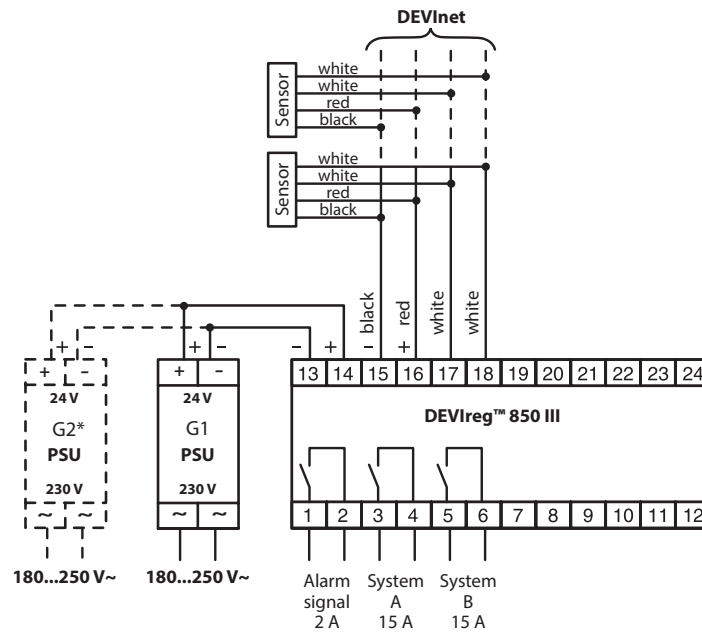

\* Additional PSU, if number of sensors is 3 or 4.

## System configurations

Zone support saves energy

DEVIreg™ 850 lets you divide your area in to 2 zones, e.g. a North and South side. In this way it is possible to save energy, when the South side is free of ice and snow faster because of the heat from the sun.

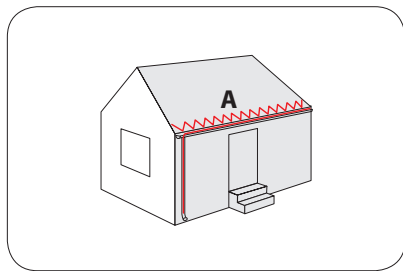

Single zone system for roofs  
(system A)

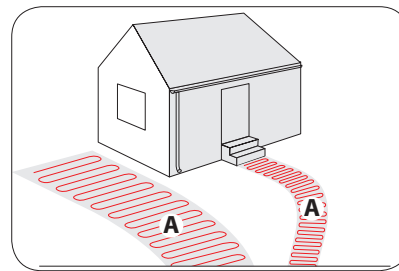

Single zone system for ground  
(system A)

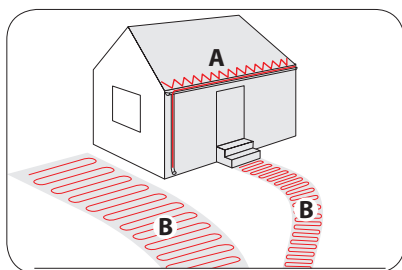

Combined system -  
one zone for roof (system A),  
one zone for ground (system B)

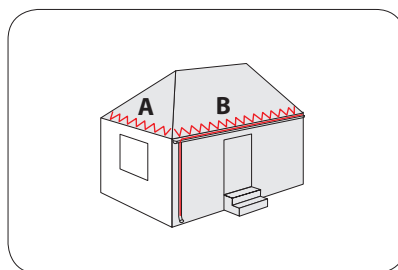

Two zone system for roofs  
(systems A and B)

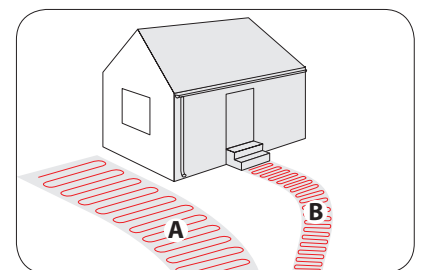

Two zone system for ground  
(systems A and B)

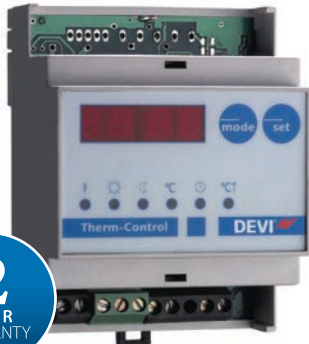

## DEVIreg™ Therm Control

The DEVIreg™ Therm Control DHB 330 is designed for controlling DEVIhotwatt™ self-limiting heating cables used for temperature maintenance inside pipes. The temperature can be regulated within a range of 35 °C to 70 °C.

Due to the built-in timer it is possible to switch the system off once every 24 hours eg at night where there is usually not at great demand for hot water, however this will of course affect the comfort. The system can be set up to operate at max. temperature once a week to suppress the Legionella bacteria.

A power limiter has been built-in in order not to overload the fuse. After switching the system on it will slowly start up (about 8 min.).

### Benefits:

- Legionella protection
- DIN rail mounting
- Built-in power limiter
- Timer

Type	Value
Operation voltage	230V~ +10%/-15%
Relay	16 A
Ambient temperature	-10 °C to 50 °C
Temperature range	35 °C to 70 °C
Cable max length with 16 A:	
DEVIhotwatt™ 55	120 m
DEVIhotwatt™ 70	80 m
Power consumption	3 VA
Battery backup	12 hours
IP class	20
Protection class	Class II - <input type="checkbox"/>
Dimensions (H/W/D)	90 mm x 71 mm x 58 mm
Weight	0.25 kg

### Types

Item no.	Product name	EAN no.
140F1094	<b>Therm-Control DHB 330</b>	5703466208953







## DEVItemp™ Fan Heater

The DEVItemp™ fan heater is a complete portable heating system that provides a temporary but efficient heating solution. The fan heater is designed to withstand heat and cold, damp and heavy use on construction sites.

The built-in thermostat ensures that the required temperature remains constant, while keeping electricity consumption as low as possible. The fan heater can be used as a portable heater or be permanently installed.

### Benefits:

- Rugged construction
- Corrosion-resistant
- Portable or permanent installation
- Easy regulation, five-step control unit for airflow
- Thermostat to ensure required temperature remains constant
- IP Class 44

### Standard compliance:

- IEC60335-2-96

Type	Value
Timer thermostat	On types named "T" up to 24 hours presetting.
Adjustable thermostat	3 - 6 KW 0°C to 40°C. 9 - 21 KW 0°C to 40°C.
Safety thermostat	3 - 6 KW = 110°C. 9 - 21 KW = 160°C. 3 - 21 KW = 125°C.
IP Class	IP X4
Colour	RAL 7004

### Types

Item no.	Type	W x H x D [mm]	Volatage	K / W	m <sup>3</sup> / h	Temp. [°C]	Weight [kg]	dB	EAN no.
69810562	303T	410 x 435 x 420	230	3	400 / 650	14 / 19	12.0	32 - 35	5703464010633
69810554	103T	410 x 435 x 420	3 x 400	3	400 / 650	14 / 19	13.9	32 - 35	5703464010619
69811537	106T	410 x 435 x 420	3 x 400	6	400 / 650	21 / 28	14.2	33 - 42	5703464010626
69812543	109T	410 x 435 x 420	3 x 400	9	400 / 650	36 / 45	14.9	33 - 42	5703464010039
69812550	115S	505 x 540 x 510	3 x 500	15	800 / 1400	26 / 30	23.6	42 - 52	5703466168196
69813509	115T	505 x 540 x 510	3 x 400	15	800 / 1400	26 / 30	23.6	42 - 52	5703464003437
69814515	121T	505 x 540 x 510	3 x 400	21	800 / 1400	36.5 / 42	25.7	42 - 52	5703464008432

### Accessories

Item no.	Type	Specification	EAN no.
19400514	Wall mounting kit	For DEVItemp™ 303T, 103T, 106T, 109T	5703435010464
19400522	Wall mounting kit	For DEVItemp™ 115S, 115T, 121T	5703435010471



## DEVItronic™

DEVItronic™ anti-condensation heater provides the perfect solution to avoid condensation problems in shielded electrical installations like boards and control cabinets.

DEVItronic™ solves the problem with moisture and condense by increasing the temperature a few degrees above the surrounding temperature.

DEVItronic™ has a large surface and a low surface temperature, and thus the heating element will not damage print and plastic cabinets.

### Benefits:

- Rugged construction
- Corrosion-resistant
- IP Class 55

### Standard compliance:

- IEC 60335-1:2012
- IEC 60335-2-30:2009

### Approvals:



Type	Value
Temperature range	-40 °C to 45 °C
Cold lead	0,5 m
IP Class	IP 55

### Types

Item no.	Item	Type	Operation voltage	Effect @ 10 °C	H x W x D (mm)	Profile	EAN no.
60800075	DEVItronic™ 75 mm	PTC	12 - 48 V	15 W	75 x 72 x 57	Star-shape	5703435010532
60802071	DEVItronic™ 100 mm	PTC	12 - 48 V	20 W	100 x 116 x 33	Double	5703435010563
60802204	DEVItronic™ 250 mm	PTC	12 - 48 V	40 W	250 x 116 x 33	Double	5703435010594
60800109	DEVItronic™ 75 mm	PTC	110 - 240 V	15 W	75 x 72 x 57	Star-shape	5703435010549
60802105	DEVItronic™ 100 mm	PTC	110 - 240 V	20 W	100 x 116 x 33	Double	5703435010570
60802253	DEVItronic™ 250 mm	PTC	110 - 240 V	40 W	250 x 116 x 33	Double	5703435010600
60802113	DEVItronic™ 100 mm	PTC	220 - 440 V	20 W	100 x 116 x 33	Double	5703435010587
60802261	DEVItronic™ 250 mm	PTC	220 - 440 V	40 W	250 x 116 x 33	Double	5703435010617
60801156	DEVItronic™ with 50 dg termo, 145 mm	OHMSK	240 V	70 W	142 x 72 x 57	Star-shape	5703435010556
60802402	DEVItronic™ with 50 dg termo, 250 mm	OHMSK	240 V	100 W	250 x 116 x 33	Double	5703435010624
60802451	DEVItronic™ with 50 dg termo, 250 mm	OHMSK	240 V	160 W	250 x 116 x 33	Double	5703435011034



## DEVlrail™

DEVlrail™ is a towel drier that is ideal for bathrooms, kitchens and utility rooms. It is also a great solution for hotels.

The towel drier is a low energy product that uses no more current than an ordinary light bulb.

The design of DEVlrail™ is simple and looks good with all kinds of interior design. It is available in three sizes in both chrome and white.

### Benefits:

- Low energy consumption
- Simple design
- Easy to install

### Standard compliance:

- EN 60335-1:2002
- EN 60335-2-43:2003

Type	V alue
Operation voltage	230V
Temperature rises of the surface without textiles	Max. 60 °C
IP Class	44
Protection class	Class II - <input type="checkbox"/>

### Types

Item no.	Type	Description	Wattage	EAN no.
98806151	<b>DEVlrail™ H20C</b>	Chrome	20 W	5703464010275
98806144	<b>DEVlrail™ H20H</b>	White	20 W	5703464010268
98804958	<b>DEVlrail™ H40C</b>	Chrome	40 W	5703435010952
98804941	<b>DEVlrail™ H40H</b>	White	40 W	5703435011027
98808157	<b>DEVlrail™ H60C</b>	Chrome	60 W	5703464010305
98808140	<b>DEVlrail™ H60H</b>	White	60 W	5703464010299

### Accessories

Item no.	Description	EAN no.
98805013	Assembly kit towel rail, white	5703464006223
98805021	Assembly kit towel rail, chrome	5703464006230
98805195	Fittings towel rail, chrome	5703464010053
98805203	Fittings towel rail, white	5703464010060



DEVlrail™ H20H White



DEVlrail™ H40C Chrome







DEVlrail™ H60H White

## Accessories and spare parts for cables and mats

Article no.	EAN no.	Name	Description	
<b>Fastening for down pipes</b>				
19805258	5703466003763	<b>Cable fixing for down - pipe suspension 25 pcs</b>	170 x 230 x 20 mm	
19406007	5703466154229	<b>Relief clip single for drain pipes</b>	35 x 10 x 10 mm	
19406008	5703435003015	<b>Relief clip for drain pipes</b>	50 x 10 x 10 mm	
19406016	5703435003022	<b>Entlastungsseil</b>	500 x 15 x 1 mm	
19805241	5703435003060	<b>Longlinked chain 4 mm c4 x 32 din 5685 fzn</b>	470 x 160 x 260 mm	
19805449	5703435003077	<b>Traverse v 2 a</b>	288 x 25 x 5 mm	
<b>Fastening for roof and gutters</b>				
19808234	5703466214671	<b>DEVIfast™ 5 m Metal In box</b>		
19808236	5703466214688	<b>DEVIfast™ 25 m Metal In box</b>		
19808238	5703466214695	<b>DEVIfast™ 25 m Copper In box</b>		

Article no.	EAN no.	Name	Description	
19808185	5703466240397	<b>DEVIfast™ Double Special RB 25m</b>	Cable types - Resistive Width - 50 mm Length - 25 m Fixing distance - 10 cm (on one side) Cable C-C distance - 30-35 mm Material - Galvanized steel	
19808183	5703466240380	<b>DEVIfast™ Double for SLC RB 25m</b>	Cable types - SLC and resistive Width - 65 mm Length - 25 m Fixing distance - 15 cm (on one side) Cable C-C distance - 40-45 mm (SLC) Material - Galvanized steel	
19805192	5703466134757	<b>DEViClip™ roofhook 25 pcs, installation kit</b>	230 x 320 x 20 mm	
19805193	5703466145470	<b>DEViClip™ guardhook Install. kit 20+10+30</b>	Base Roof accessories - 20 pcs. Angle Roof accessories - 10 pcs. Cable Strip 7,6x203 mm, black - 30 pcs.	
140F1511	5703466229897	<b>Roof Gutter Clip with hinge bag 25 pcs</b>	250 x 150 x 150 mm	

### Fastening for floors

19805220	5703466173213	<b>DEViClip™ c-c</b>	1050 x 50 x 60 mm	
19805236	5703466172117	<b>DEViClip™ twist</b>	330 x 290 x 50 mm	
19808234	5703466214671	<b>DEVIfast™ 5 m Metal In box</b>		
19808236	5703466214688	<b>DEVIfast™ 25 m Metal In box</b>		
109030	5703466134740	<b>Montagestege type ms 5,6-6,5 mm - 25mm</b>	980 x 10 x 10 mm	
19805266	5703435009222	<b>Montagestege type ms 6,6-8,0 mm - 25mm</b>	1000 x 10 x 10 mm	

Article no.	EAN no.	Name	Description	
19805905	5703466061466	<b>Synthetic nail, 100 pcs.</b>	bag with 100 pcs	
19805908	5703466086902	<b>Synthetic nail, 50 pcs.</b>	bag with 50 pcs	
<b>Fittings</b>				
12500120	5703466111543	<b>Sensor End-Cap Brass f. flex-pipe ø6,7</b>	4 x 1 x 1 mm	
18055300	5703466128893	<b>Flexkit for DEVIcell™</b>	170 x 250 x 20 mm	
109200	5703466194560	<b>EPS-Randplatten W25 DEVIcell™ L100</b>	1000 x 15 x 250 mm	
15992250	5703466129340	<b>Connective clips for DEVIcell Dry</b>	Connective plastic clips for mounting plate Devicell Dry	
<b>Cold leads</b>				
140F0900	5703466233320	<b>DTWC Cold Lead w/Screen, 2x1,5mm<sup>2</sup>, DEVIsnow™, DTCE™</b>		
140F0901	5703466233337	<b>DTWC Cold Lead w/Screen, 2x2,5mm<sup>2</sup>, DEVIsnow™, DTCE™</b>		
140F0902	5703466233344	<b>DTIK Cold Lead Full screened, 2x2,5mm<sup>2</sup>, DEVIasphalt™</b>		
140F0903	5703466233351	<b>DSWA Cold Lead w/Screen, 1x1,5mm<sup>2</sup>, DEVIbasic™</b>		
140F0904	5703466233368	<b>DSWA Cold Lead w/Screen, 1x2,5mm<sup>2</sup>, DEVIbasic™</b>		
140F0905	5703466233375	<b>DSWA Cold Lead w/Screen, 2x4,0mm<sup>2</sup>, DEVIbasic™</b>		
140F0906	5703466233382	<b>DTWB Cold Lead w/Screen, 2x1,0mm<sup>2</sup>, DEVIimat™</b>		
140F0907	5703466233399	<b>DTCL Cold Lead, 3x1,5mm<sup>2</sup>, DEVIflex™, DEVI-safe™</b>		
140F0908	5703466233405	<b>DTCL Cold Lead, 3x2,5mm<sup>2</sup>, DEVIflex™, DEVI-safe™</b>		



Article no.	EAN no.	Name	Description	
<b>Crimp sets</b>				
18055249	5703466199251	<b>DEVICrimp™ for DEVIsnow (DTCE)</b>	Shrink tube 19/5 Black 135 mm - 1 pc. Shrink tube 18/4,5 Clear 70 mm - 1 pc. Spacer - 1 pc. Double tubular rivet 1,5-2,5mm <sup>2</sup> - 3 pcs.	
18055230	5703466068991	<b>DEVICrimp™ assemblykit dk 2-cond.Cs-2c</b>	170 x 230 x 20 mm	
18055240	5703435037980	<b>DEVICrimp™ repair-set dsvf 1-cond. For devimat</b>	170 x 230 x 20 mm	
18055355	5703466195192	<b>DEVICrimp™ ass/repair kit 2-cond. for DEVlasphalt (DTIK)</b>	Shrink tube 20/6 HTC-SCM-HD Black 160 mm - 2 pcs. Shrink tube 18/4,5 Clear 70 mm - 2 pcs. Spacer - 2 pcs. Double tubular rivet 1,5-2,5mm <sup>2</sup> - 6 pcs. DTWK 25 cold tail - 0,3 m	
18055442	5703466003435	<b>DEVICrimp™ kit 1-cond. Assembly or repair gb/fi</b>	Shrink tube 12/3 Black - 15 cm CU-socket - 28 cm Shrink tube 12/3 Black - 0,2 m Shrink tube 6/1,4 Thin wall Black - 8 cm Double tubular rivet 1,5-2,5mm <sup>2</sup> - 2 pcs. Wire CU BLW 0.248 R/m 0,30mm K-200 16kg - 0,64 m	
18055510	5703466074091	<b>DEVICrimp™ rep-set dtvf/dtif 2-cond for imat no/se/de</b>	170 x 230 x 20 mm	
18055350	5703466003381	<b>DEVICrimp™ ass/repair kit 2-cond. Cs2a/cs2b</b>	Doubl. tubular rivet 0,5-1,0mm <sup>2</sup> - 4 pcs. Shrink tube 6/1,4 Thin wall Black - 4 cm Double tubular rivet 1,5-2,5mm <sup>2</sup> - 2 pcs. Shrink tube 12/3 Black - 0,4 m Shrink tube 6/1,4 Thin wall Black - 18 cm CU-socket - 0,3 m Wire CU BLW 0,248 R/m 0,30 mm K-200 16 kg - 0,64 m Shrink tube 19/5 Black with glue - 0,4 m DTWC 15 Halogen free 2x1,5mm <sup>2</sup> w/screen - 0,3 m Tubular rivet 0,5-1,0mm <sup>2</sup> - 1 pc.	
18055240	5703435037980	<b>DEVICrimp™ assembly kit de with screen</b>	170 x 230 x 20 mm	

Article no.	EAN no.	Name	Description	
19805480	5703466003824	<b>DEVICrimp™ assembly set dk 4-cond. Type cs-4a</b>	<p><b>Assembly set for 4-conductors</b>  <b>DEVImulti - set for 1 connection: either cold tail or end muff.</b></p> <p>Shrink tube 19/5 Black 25 cm - 1 pc.                      Shrink tube 12/3 Black 15 cm - 1 pc.                      CU-<b>stocking</b> 25 cm - 1 pc.                      Double tubular rivet 1,5-2,5mm<sup>2</sup> - 5 pcs.                      Shrink tube 6/1,4 Black 5 cm - 4 pcs.                      Wire CU 0,30 mm - 1 m</p>	
19805712	5703466003855	<b>DEVICrimp™ assembly set dk 4-cond. Type cs-4b</b> <b>DEVICrimp™ terminal set dk 4-cond. Type cs-4/1</b>	<p><b>Assembly set for 4-conductors</b>  <b>DEVImulti - set for 2 connections: cold tail and end muff.</b></p> <p>Shrink tube 19/5 Black 25 cm - 2 pcs.                      Shrink tube 12/3 Black 15 cm - 2 pcs.                      CU-<b>stocking</b> 25 cm - 2 pcs.                      Double tubular rivet 1,5-2,5mm<sup>2</sup> - 10 pcs.                      Shrink tube 6/1,4 Black 5 cm - 8 pcs.                      Wire CU 0,30 mm - 1 m</p>	
86000080	5703464006728	<b>Joining-kit for silicone cable</b>	200 x 300 x 30 mm	
19805704	5703466003848	<b>Repair kit cables 2 cond. Concrete/støbesæt gb/dk</b>	130 x 265 x 75 mm	
<b>Tapes</b>				
19405877	5703435002971	<b>Acrylic coated cloth tape 15 mm x 50 m (Textilklebeband)</b>	<p>Strong acrylic coated cloth tape for almost every application with high adhesion even on rough surfaces, e.g. for fixing cable to concrete or on pipe, insulating of wires, etc.</p> <p><b>Color</b> gray  <b>Backing material</b> acrylic-coated cloth  <b>Total thickness</b> 310 µm  <b>Type of adhesive</b> natural rubber  <b>Adhesion to steel</b> 3.3 N/cm  <b>Elongation at break</b> 13 %  <b>Tensile strength</b> 100 N/cm  <b>Temperature resistance</b> 130 °C (30 min)  <b>Mesh</b> 145 count per inch<sup>2</sup>  <b>Producer type</b> tesa® 4651</p>	
19805076	5703435003053	<b>Tape aluminium 38 mm x 50 m</b>	<p>Self-adhesive, with 2-colour warning label, max. 75 °C</p> <p><b>Backing</b> Aluminium foil  <b>Adhesive</b> Waterbased Acrylic  <b>Liner</b> Monosiliconized Paper  <b>Adhesion/Steel</b> 8 N/ 38 mm  <b>Tensile strength</b> 57,5 N/ 25 mm  <b>Total thickness</b> 60 µm</p>	
19805078	5703466130469	<b>Tape aluminium 25 mm x 25 m</b>	<p>Self-adhesive, with 2-colour warning label, max. 75 °C. For DEVIpipeline™ 10 (DPH-10)</p> <p><b>Backing</b> Aluminium foil  <b>Adhesive</b> Waterbased Acrylic  <b>Liner</b> Monosiliconized Paper  <b>Adhesion/Steel</b> 8 N/ 25 mm  <b>Tensile strength</b> 57,5 N/ 25 mm  <b>Total thickness</b> 60 µm</p>	





Article no.	EAN no.	Name	Description	
<b>Glue</b>				
18055351	5703466114940	<b>Hotmelt gluesticks 25pcs</b>	170 x 250 x 20 mm	
<b>Tools</b>				
19001220	5703466161456	<b>DEVI continuity tester</b>	125 x 80 x 30 mm	
19110013	5703466111383	<b>DEVI tector™ ii, set</b>	700 x 350 x 500 mm	
19805250	5703466173220	<b>DEVI turntable™</b>	400 x 400 x 70 mm	

## Accessories and spare parts for self-limiting heating cables



Article no.	EAN no.	Name	Description	
<b>DEVIconnecto</b>				
19808360	5703466103067	<b>DEVIconnecto B-A Connection</b>	130 x 265 x 75 mm	
19808361	5703466103074	<b>DEVIconnecto B-C Heating tape connection</b>	130 x 265 x 75 mm	
19808362	5703466103081	<b>DEVIconnecto B-E End termination</b>	130 x 265 x 75 mm	
19808363	5703466103098	<b>DEVIconnecto B-S Connection termination</b>	130 x 265 x 75 mm	
19808364	5703466103104	<b>DEVIconnecto B-T, T-Junction + End termination</b>	130 x 265 x 75 mm	
19808365	5703466103111	<b>DEVIconnecto B-TE2 Junction + 2 End termination</b>	130 x 265 x 75 mm	
19808366	5703466103128	<b>DEVIconnecto B-TE3 Junction + 3 End termination</b>	130 x 265 x 75 mm	
19808367	5703466103135	<b>DEVIconnecto B-X, X-Junction + 2 End termination</b>	130 x 265 x 75 mm	
19808390	5703466125021	<b>DEVIconnecto Bracket, ref AH 61400005</b>	Braket for installation outside the insulation 	

Article no.	EAN no.	Name	Description	
<b>DEVI EasyConnect</b>				
98300870	5703466214503	<b>DEVI EasyConnect EC-1 Power connection</b>		
98300871	5703466214510	<b>DEVI EasyConnect EC-T1 Heating cable connection</b>		
98300872	5703466214527	<b>DEVI EasyConnect EC-ETK End termination</b>		
98300873	5703466214534	<b>DEVI EasyConnect EC-1+ETK Power con. + end term.</b>		
98300874	5703466214541	<b>DEVI EasyConnect EC-T2 Heating cable con x 2</b>		
98300875	5703466214558	<b>DEVI EasyConnect EC-2 Power connection x 2</b>		
98300876	5703466214565	<b>DEVI EasyConnect EC-3 Power connection x 3</b>		

Article no.	EAN no.	Name	Description	
<b>Crimp sets for SLC</b>				
19805753	5703466003879	<b>Con. Kit, cable/box self-limiting cables, dk/gb</b>	170 x 230 x 20 mm	
19805761	5703466003886	<b>Con. Kit, cable/cold tail self-limiting cables, dk/gb</b>	170 x 230 x 20 mm	
19805779	5703466003893	<b>Con. Kit, cable/cable selflimiting cables, dk/gb</b>	170 x 230 x 20 mm	
19806401	5703466071830	<b>DEVicrimp for DPH-10, Connection box</b>	170 x 230 x 20 mm	
19806415	5703466074985	<b>DEVicrimp for DFH-15+DPH-10, Connection cable</b>	160 x 245 x 20 mm	
19806421	5703466169780	<b>DEVicrimp™ t-connection for selflimiting cables</b>	230 x 320 x 20 mm	
19400126	5703435002810	<b>ANSCHLGAR. M/KLEM Z. VERB. VON FLEXIB.KALT</b> (Anschlussgarnitur, mit Klemmstein zur Verbindung von flexibler Kaltleitung und Heizband, Endabschluss)	Connection kit with clamping block for SLC: cold lead and heating cable connection, with end-termination, heat shrink technology. Shrinktube 24/8 Black 12 cm - 1 pc. Clamping block 5x2,5 mm <sup>2</sup> - 1 pc. Shrinkfit end-cap 12/4 - 1 pc. Shrinktube 12/3 Black, 2,5 cm - 1 pc. Shrinktube 16/3 yellow-green, 2,5 cm - 1 pc. Uninsulated ferrule 1,5 mm <sup>2</sup> , 7 mm - 2 pcs.	
19400142	5703435002834	<b>Endcap</b>	245 x 10 x 170 mm	

Article no.	EAN no.	Name	Description	
<b>Junction box and accessories for SLC</b>				
19400167	5703435002858	<b>Polyester box ABSC for DEVlceguard™ and DEVlpipeguard™</b>	For SLC (DEVlceguard, DEVlpipeguard)	
19405851	5703435002964	<b>Bracket</b>	Fitting for connection of housing (19400167) to pipes	
19400100	5703435002797	<b>Anschlussgarnitur fuer poestergehause, pg13,5 m. EN</b>	250 x 25 x 165 mm	
11010410	5703435031001	<b>Insulation introduction</b>	With mounting plate M20 60x60x1 mm AISI304; Cable gland U17 M20x1,5; Cable gland M25	
00109007	5703466167397	<b>Connection kit for DEVlpipeguard 30/60 Industry (PT-30/60) heating cables</b>	With clamping block for the connection of cold lead and heating cable, shrink end-cap, shrink tubes, bitumen gaskets and ferrules. Shrinktube 33/5,5 Black no glue, 17 cm - 1 pc. Clamping block 5x2,5 mm <sup>2</sup> - 1 pc. Shrink end-cap 20/8, 75 mm - 1 pc. Shrinktube 12/3 Black, 2,5 cm - 1 pc. Shrinktube 16/3 yellow-green, 2,5 cm - 1 pc. Bitumen gasket 1,5x85x35 mm - 3 pcs. Wire end ferrule 1,5 mm <sup>2</sup> , 7 mm - 2 pcs. Wire end ferrule 2,5 mm <sup>2</sup> , 8 mm - 1 pc.	
00109026	5703466135778	<b>Connection kit for DEVlpipeguard 30/60 Industry (PT-30/60) heating cables</b>	For mounting in connection box with crew connections. With cable gland M20x1,5 with locknut, shrink end-cap, shrink tubes, bitumen gasket and ferrules. Shrink end-cap 20/8, 75 mm - 1 pc. Bitumen gasket 1,5x85x35 mm - 1 pc. Cable gland U17 M20x1,5 - 1 pc. Shrinktube 12/3 Black, 2 cm - 2 pcs. Shrinktube 4/1 Black, 8 cm - 2 pcs. Shrinktube 16/3 yellow-green, 8 cm - 1 pc. Wire end ferrule 1,5 mm <sup>2</sup> , 7 mm - 2 pcs. Wire end ferrule 2,5 mm <sup>2</sup> , 8 mm - 1 pc.	
19805787	5703435009192	<b>Flathole packing PG16</b>	10 x 5 x 10 mm	





Article no.	EAN no.	Name	Description	
<b>Fastening</b>				
19805300	5703466075104	<b>Heizbandhalter v2a 10 cm cc 10 cm</b>	1000 mm x 30 mm	
19805301	5703466195789	<b>Heizbandhalter v2a 15 cm cc 15 cm</b>	1000 mm x 30 mm	
19805746	5703435010501	<b>Spaceclip for self-limiting cables</b>	300 x 5 x 70 mm	
109004	5703466090282	<b>Cable ties (1 bag with 100 pcs)</b>	300 x 120 x 20 mm	
19805366	5703435041697	<b>3/4" + 1" Pipe fitting for DEVipeheat™ 10 (DPH-10)</b>	With rubber conic sliced sleeve, oval hole	
19805372	5703466164624	<b>3/4" + 1" Pipe fitting for blue DEVlaqua™ 9T</b>	With rubber conic sleeve, round hole	

## Accessories and spare parts for dry solutions

Article no.	EAN no.	Name	Description	
<b>DEVIdry™</b>				
19911009	5703466197301	<b>DEVIdry Pro Supply cord 3m</b>	320 x 400 x 20 mm	
19911100	5703466177938	<b>DEVIdry CD Circuit device</b>	170 x 250 x 20 mm	
19911110	5703466177945	<b>DEVIdry X25 Extension cord</b>	200 x 110 x 40 mm	
19911111	5703466177952	<b>DEVIdry X100 Extension cord</b>	200 x 110 x 40 mm	
19911112	5703466177969	<b>DEVIdry X200 Extension cord</b>	200 x 110 x 40 mm	
<b>DEVIfoil™</b>				
106010	5703466124086	<b>Cold lead 1 x 1.5 mm<sup>2</sup> Black 50 m</b>	210 x 210 x 65 mm	
106011	5703466124093	<b>Cold lead 1 x 1.5 mm<sup>2</sup> Blue 50 m</b>	210 x 210 x 65 mm	
106012	5703466124109	<b>Cold lead 1 x 2.5 mm<sup>2</sup> Black 50 m</b>	210 x 210 x 65 mm	
106013	5703466124116	<b>Cold lead 1 x 2.5 mm<sup>2</sup> Blue 50 m</b>	210 x 210 x 65 mm	

Article no.	EAN no.	Name	Description	
98931300	5703466147894	<b>Duct tape 50 mm x 50 m (Lærredstape)</b>	<p>Strong self adhesive tape with typical duct features for a wide range of applications, e.g. to connect Depron® insulation plates together. It consists of a 27 mesh woven PET/cotton fabric backing coated with a natural rubber adhesive.</p> <p>Backing PE laminated cloth            Total thickness 230 µm            Type of adhesive natural rubber            Adhesion to steel 4.4 N/cm            Elongation at break 18 %            Tensile strength 30 N/cm            Temperature resistance 95 °C (30 min)            Mesh 27 count per inch<sup>2</sup>            Producer type tesa® 4662</p>	
98931301	5703466147900	<b>Tape 2-sided 25 mm x 50 m, double-faced</b>	<p>Double-sided tape with a non-woven backing. General purpose mounting, e.g. to secure DEVIfoil™ to Depron®. The thick layer of adhesive bonds well on uneven surfaces and has a very high initial bond.</p> <p>Backing material non-woven            Total thickness 110 µm            Type of adhesive synthetic rubber            Adhesion initial /&gt;14 days Steel 12/13 N/cm, PE 5,5/7 N/cm, PP 7/12 N/cm, PVC 9/12,5 N/cm            Temp. resistance short term 80 °C, long term 40 °C            Producer type tesa® 51570</p>	
98931302	5703466147917	<b>Vulktape vm 38 mm x 6 m</b>	For isolation of DEVIfoil™ connectors after connecting to the foils powerlines	
106014	5703466125137	<b>Depron®, 3 mm, 40 pc (1 box), -60°C to +70°C, 80 cm x 125 cm</b>	1260 x 820 x 135 mm	
106015	5703466125144	<b>Depron®, 6 mm, 20 pc (1 box), -60°C to +70°C, 80 cm x 125 cm</b>	1260 x 820 x 135 mm	
106017	5703466207338	<b>Depron glue, 5 kg</b>	195 x 195 x 140 mm	

Article no.	EAN no.	Name	Description	
98931203	5703466128893	<b>Connector for DEVIfoil™ Floor, 500 pc (1 box)</b>	170 x 150 x 140 mm	
98931204	5703466120293	<b>DEVIfoil™ Floor Insulation cover</b>	250 x 150 x 25 mm	
98931205	5703466128923	<b>Pliers for connectors</b>	150 x 20 x 120 mm	

## Accessories and spare parts for controls





Article no.	EAN no.	Name	Description	
<b>For DEVIreg™ 233</b>				
19805922	5703466164587	<b>DEVIreg™ 233 Front, knob 1 pcs. in box, White</b>		
19805923	5703466164594	<b>DEVIreg™ 233 Front, knob 1 pcs. in box, Light grey</b>		
19805924	5703466164600	<b>DEVIreg™ 233 Front, knob 1 pcs. in box, Charcoal grey</b>		
<b>For thermostats with flush-mounted fixing</b>				
19808922	5703435003381	<b>Wall box ELKOS45/6 w/stub E-12 237 08</b>	130 x 70 x 50 mm	
19808930	5703435003398	<b>Multiboks PFXP/r&gt;r E 12 237 40</b>	76 x 71 x 55 mm	
19808932	5703466078242	<b>Wall mounting Box w. ELKO Frame</b>	87 x 87 x 40 mm	
<b>For DEVIreg™ 610</b>				
19116920	5703465002873	<b>Pipe assembly set, dk</b>	85 x 85 x 32 mm	





Article no.	EAN no.	Name	Description	
<b>For DEVireg™ 850</b>				
19119977	5703466208359	<b>Sensor tube and cap For DEVireg™ 850</b>		
140F1089	5703466209721	<b>DC-PSU, 24V/24W, Din rail, 4-modul</b>	90 x 90 x 92 mm	
<b>Sensors and accessories for sensors</b>				
140F1090	5703466209295	<b>Room sensor FUGA-frame</b>	63 x 63 x 25 mm, NTC 15 kOhm at 25 °C, IP 20	
140F1095	5703466209684	<b>Room sensor, 426-frame</b>	85 x 85 x 30 mm, NTC 15 kOhm at 25 °C, IP 20	
140F1096	5703466209691	<b>Outdoor sensor IP44</b>	80 x 50 x 35 mm, NTC 15 kOhm at 25 °C, IP 44	
140F1091	5703466209301	<b>Sensor cable 3 m, 15 kOhm, Santropene</b>	Wire sensor, 2x0,75 mm <sup>2</sup> , NTC 15 kOhm at 25 °C, Ø5 mm, black Santropene (TPV) outer sheath, IP 67, Temp. range: -25 °C to 90 °C	
19121445	5703466115015	<b>Sensor cable 40 m, 15 kOhm, Santropene</b>		
140F1092	5703466209318	<b>Outdoor sensor 2,5 m, 15 kOhm, PVC, DIN 44574</b>	Wire sensor, 2x0,75 mm <sup>2</sup> , NTC 15 kOhm at 25 °C, Ø8 mm, white PVC outer sheath, IP 67, Temp. range: -25 °C to 70 °C	
140F1098	5703466210734	<b>Outdoor sensor 10 m, 15 kOhm, PVC</b>		
140F1097	5703466209707	<b>Silicon temperature sensor for DEVireg™ 330 (60-160°C), NTC 16,7 kOhm @ 100°C</b>	Wire sensor, 2,5 m, 2x0,75 mm <sup>2</sup> , NTC 16,7 kOhm at 100 °C, IP 65, Temp. range: 50 °C to 170 °C	

Article no.	EAN no.	Name	Description	
140F1114	5703466215234	<b>Flexpipe Ø6,7 mm, 2,5 m</b>	170 x 240 x 20 mm, inner Ø6,7 mm, outer Ø10 mm	
19809106	5703466178607	<b>Flexpipe Ø6,7 mm, 2,5 m with plug</b>	170 x 230 x 25 mm, inner Ø6,7 mm, outer Ø10 mm	
19809100	5703435009314	<b>AstroFlex FFTYL Ø8,5 mm, roll 50 m</b>	400 x 130 x 400 mm, Flexpipe for sensor and cable protection.	
12500112	5703435031025	<b>Sensor shell M20</b>	95 x 20	



## Accessories and spare parts for other heating elements

Article no.	EAN no.	Name	Description	
<b>DEVIheat Mirror</b>				
18055354	5703466124420	<b>Accessory kit Elements Transition Pipe</b>	Mounting kit for 3 m wire sensor	
<b>DEVlrail™</b>				
98805195	5703464010053	<b>Fittings towelrail chrome 20w/40w/60w new model 12c</b>	240 x 150 x 60 mm	
98805203	5703464010060	<b>Fittings towelrail white 20w/40w/60w, new model 12</b>	240 x 150 x 60 mm	
98805013	5703464006223	<b>Assemblykit for towelrail white</b>	270 x 150 x 10 mm	
98805021	5703464006230	<b>Assemblykit for towel, chrome</b>	270 x 150 x 30 mm	

Article no.	EAN no.	Name	Description	
<b>DEVIttemp™</b>				
19400514	5703435010464	<b>Wall mounting for DEVIttemp™ cabin A</b>	280 x 40 x 130 mm	
19400522	5703435010471	<b>Wall mounting for DEVIttemp™ cabin B</b>	360 x 150 x 40 mm	
19001924	5703466165430	<b>Button</b>	Button for DEVIttemp™ 303T, DEVIttemp™ 106T, DEVIttemp™ 109T	
19001874	5703435001332	<b>Button</b>	Button for DEVIttemp™ 115T, DEVIttemp™ 121T	
23804776	5703466168752	<b>Heating element 400 V, 2000 W</b>	Heating element for DEVIttemp™ 106T	
23804792	5703466208779	<b>Heating element 400 V, 3000 W</b>	Heating element for DEVIttemp™ 109T	
23804594	5703464001761	<b>Heating element 400 V, 3500 W</b>	Heating element for DEVIttemp™ 121T	
19002237	5703466096475	<b>3-pole thermostat 0-40°C, 125°C</b>	Thermostat for DEVIttemp™ 303T	
19001296	5703464010909	<b>3-pole thermostat 0-40°C, 165°C</b>	Thermostat for DEVIttemp™ 106T, DEVIttemp™ 109T	
19001056	5703435001257	<b>1-pole thermostat 0-40°C</b>	Thermostat for DEVIttemp™ 115T, DEVIttemp™ 121T	
19002211	5703464008524	<b>1-pole thermal fuse 160°C</b>	Thermostat for DEVIttemp™ 115T, DEVIttemp™ 121T	

# Index

Accessories and spare parts for cables and mats . . . .	109	DEVI <sup>™</sup> mat 100T (DTIF-100).....	27
Accessories and spare parts for controls . . . . .	123	DEVI <sup>™</sup> mat 150T (DTIF-150).....	28
Accessories and spare parts for dry solutions . . . . .	120	DEVI <sup>™</sup> mat 200T (DTIF-200).....	29
Accessories and spare parts for other heating elements	126	DEVI <sup>™</sup> mat DSVF-90.....	80
Accessories and spare parts for SLC . . . . .	115	DEVI <sup>™</sup> multi <sup>™</sup> PVC (DMIH), DEVI <sup>™</sup> multi <sup>™</sup> HDPE (DMIT) . . .	76
Cold stores.....	12	DEVI <sup>™</sup> pipeguard <sup>™</sup> (B) . . . . .	60
Concrete hardening . . . . .	13	DEVI <sup>™</sup> pipeguard <sup>™</sup> (T) . . . . .	64
DEVI <sup>™</sup> aqua 9T.....	45	DEVI <sup>™</sup> pipeguard <sup>™</sup> Industry.....	68
DEVI <sup>™</sup> asphalt <sup>™</sup> 30T (DTIK-30).....	56	DEVI <sup>™</sup> pipeheat <sup>™</sup> 10 (DPH-10) (B) . . . . .	44
DEVI <sup>™</sup> asphalt <sup>™</sup> 300T - 230 V (DTIK-300) . . . . .	57	DEVI <sup>™</sup> rail <sup>™</sup> . . . . .	108
DEVI <sup>™</sup> asphalt <sup>™</sup> 300T - 400 V (DTIK-300) . . . . .	58	DEVI <sup>™</sup> reg <sup>™</sup> 130, DEVI <sup>™</sup> reg <sup>™</sup> 132.....	86
DEVI <sup>™</sup> basic <sup>™</sup> 10S (DSIG-10).....	21	DEVI <sup>™</sup> reg <sup>™</sup> 233 . . . . .	96
DEVI <sup>™</sup> basic <sup>™</sup> 20S - 230V (DSIG-20) . . . . .	22	DEVI <sup>™</sup> reg <sup>™</sup> 316 . . . . .	100
DEVI <sup>™</sup> basic <sup>™</sup> 20S - 400V (DSIG-20) . . . . .	23	DEVI <sup>™</sup> reg <sup>™</sup> 330 . . . . .	98
DEVI <sup>™</sup> basic <sup>™</sup> Drum Goods (DSIG) . . . . .	24	DEVI <sup>™</sup> reg <sup>™</sup> 527 . . . . .	85
DEVI <sup>™</sup> cell <sup>™</sup> . . . . .	43	DEVI <sup>™</sup> reg <sup>™</sup> 530, DEVI <sup>™</sup> reg <sup>™</sup> 531, DEVI <sup>™</sup> reg <sup>™</sup> 532, DEVI <sup>™</sup> reg <sup>™</sup> 528, DEVI <sup>™</sup> reg <sup>™</sup> 530M . . . . .	88
DEVI <sup>™</sup> comfort <sup>™</sup> 10T (DTIR-10) . . . . .	25	DEVI <sup>™</sup> reg <sup>™</sup> 610 . . . . .	101
DEVI <sup>™</sup> comfort <sup>™</sup> 100T (DTIR-100).....	30	DEVI <sup>™</sup> reg <sup>™</sup> 850 . . . . .	102
DEVI <sup>™</sup> comfort <sup>™</sup> 150T (DTIR-150).....	31	DEVI <sup>™</sup> reg <sup>™</sup> Smart . . . . .	91
DEVI <sup>™</sup> connecto . . . . .	62	DEVI <sup>™</sup> reg <sup>™</sup> Therm Control . . . . .	104
DEVI <sup>™</sup> dry <sup>™</sup> Heating Element 55 W/m <sup>2</sup> . . . . .	38	DEVI <sup>™</sup> reg <sup>™</sup> Touch . . . . .	90
DEVI <sup>™</sup> dry <sup>™</sup> Heating Element 100 W/m <sup>2</sup> . . . . .	39	DEVI <sup>™</sup> safe <sup>™</sup> 20T - 230V.....	46
DEVI <sup>™</sup> dry <sup>™</sup> Kit 55 . . . . .	40	DEVI <sup>™</sup> safe <sup>™</sup> 20T - 400V.....	47
DEVI <sup>™</sup> dry <sup>™</sup> Kit 100 . . . . .	41	DEVI <sup>™</sup> snow <sup>™</sup> 20T - 230V (DTCE-20) . . . . .	48
DEVI <sup>™</sup> dry <sup>™</sup> Pro Kit . . . . .	42	DEVI <sup>™</sup> snow <sup>™</sup> 20T - 400V (DTCE-20) . . . . .	49
DEVI EasyConnect . . . . .	66	DEVI <sup>™</sup> snow <sup>™</sup> 30T - 230V (DTCE-30) . . . . .	50
DEVI <sup>™</sup> flex <sup>™</sup> 6T (DTIP-6).....	16	DEVI <sup>™</sup> snow <sup>™</sup> 30T - 400V (DTCE-30) . . . . .	52
DEVI <sup>™</sup> flex <sup>™</sup> 10T (DTIP-10) . . . . .	17	DEVI <sup>™</sup> snow <sup>™</sup> 300T - 230V (DTCE-300) . . . . .	53
DEVI <sup>™</sup> flex <sup>™</sup> 18T (DTIP-18) . . . . .	18	DEVI <sup>™</sup> snow <sup>™</sup> 300T - 400V (DTCE-300) . . . . .	54
DEVI <sup>™</sup> flex <sup>™</sup> 30T (DTIP-30) . . . . .	19	DEVI <sup>™</sup> snow <sup>™</sup> Drum Goods (DTCE) . . . . .	55
DEVI <sup>™</sup> foil <sup>™</sup> Ceiling . . . . .	84	DEVI <sup>™</sup> sport <sup>™</sup> (DSM3) . . . . .	82
DEVI <sup>™</sup> foil <sup>™</sup> Mirror . . . . .	83	DEVI <sup>™</sup> temp <sup>™</sup> Fan Heater . . . . .	106
DEVI <sup>™</sup> heat <sup>™</sup> 150S (DSVF-150) . . . . .	33	DEVI <sup>™</sup> tronic <sup>™</sup> . . . . .	107
DEVI <sup>™</sup> heat <sup>™</sup> Mirror 150S . . . . .	33	DTCE 100T (DTCE-100).....	34
DEVI <sup>™</sup> hightemp <sup>™</sup> (DSIX).....	78	DTCE 150T (DTCE-150).....	35
DEVI <sup>™</sup> hotwatt <sup>™</sup> (B).....	74	DTCE 175T (DTCE-175).....	36
DEVI <sup>™</sup> liceguard <sup>™</sup> 18 (B).....	70	DTCE 200T . . . . .	37
DEVI <sup>™</sup> liceguard <sup>™</sup> 18 (T).....	72	Expand your knowledge . . . . .	129
DEVI <sup>™</sup> link <sup>™</sup> CC.....	92	Fields . . . . .	10
DEVI <sup>™</sup> link <sup>™</sup> FT . . . . .	93	Floor Heating . . . . .	4
DEVI <sup>™</sup> link <sup>™</sup> RS . . . . .	94	Ice & snow melting . . . . .	6
DEVI <sup>™</sup> link <sup>™</sup> RU . . . . .	95	Pipe tracing . . . . .	8
DEVI <sup>™</sup> mat <sup>™</sup> 70T (DTIF-70) . . . . .	26		

**Note!**

The entries marked in red throughout the Product Catalogue are the main corrections and additions changed from the previous version - October 2017.

## Expand your knowledge

Danfoss Floor Heating Electrical is Europe's leading manufacturer of intelligent electrical floor heating and frost protection systems.

This position is secured by a dedicated focus on advanced and above all user-friendly systems, developed in the world's largest competence center for floor heating.

## Electrotechnical formulas

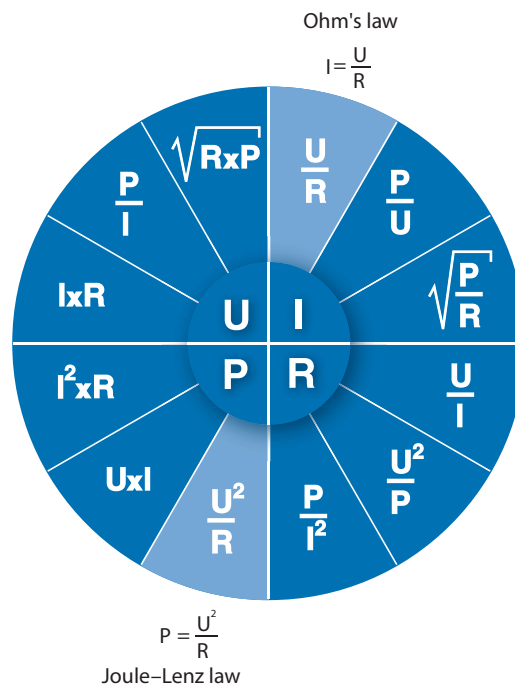

### Cable calculation formulas

$$L = U / \sqrt{(p \cdot r)},$$

$$r = U^2 / (L^2 \cdot p),$$

$$p = U^2 / (L^2 \cdot r),$$

where:

- L – length of heating cable (m);
- U – supply voltage (V);
- p – specific output (W/m);
- r – specific resistance (Ohm/m).

## Your local DEVI<sup>®</sup> team is ready to help



### Sales office location

Danfoss A/S  
Salg Danmark  
Jegstrupvej 3  
8361 Hasselager  
Phone: +45 7488 8500  
E-mail: mail@devi.com

DEVI - an abbreviation of Dansk El-Varme Industri - was established in Copenhagen, Denmark, in 1942.

At the beginning DEVI manufactured heating elements for industrial purposes. In the early sixties DEVI starts to take an interest in electric heating cables and the oldest heating cable installations are from the early sixties.

### From Copenhagen to Vejle

As is the case with many other Danish companies DEVI chooses to move its activities from Copenhagen to the provinces during the seventies and in the early eighties. DEVI settles in Vejle where the communications such as motorway and railway are good and which is close to an international airport. But first of all the industry has easy access to motivated and qualified manpower.

### The modern DEVI starts in 1985

Over the sixties and seventies the industrial heating elements were still the far most important product group but in the early eighties a considerable export of heating cables begin, to begin with to Finland. The first subsidiary companies in Germany, Sweden and Norway are established in the mid eighties and the export adventure starts to take shape. Throughout the nineties things start speeding up and a number of subsidiary companies are established, among other places in the previous East bloc countries.

### European Market Leader

Since the beginning in Copenhagen in 1942 things have accelerated. Today DEVI is Europe's leading company within the industry with a considerable market share.

# Local support - when and where you need it

## Contact DEVI if you are looking for:

- finding local DEVI wholesalers and retailers
- information on DEVI floor heating products
- information on DEVI control systems including thermostats
- information on DEVI bathroom solutions
- information on DEVI condensate pipe frost protection
- information on DEVI accessories
- technical information
- user instructions

We provide you with excellent service, from choosing and designing the correct system, through to installation and unlimited technical support.

**Danfoss A/S**  
Electric Heating Systems  
DK-7100 Vejle  
Tel.: +45 7488 8500  
Visit [devi.com](http://devi.com)



**DEVI**<sup>®</sup>   
bv Danfoss